

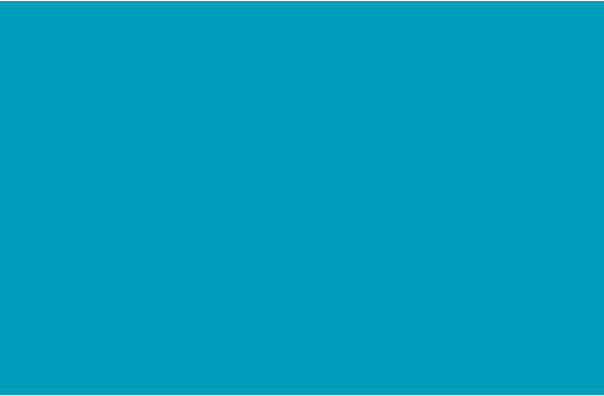

ARCHITECTURAL STREET FURNISHINGS

www.asfco.co.uk info@asfco.co.uk 01484 401414

# BOLLARDS CATALOGUES



STAINLESS  
STEEL  
BOLLARDS



STEEL  
BOLLARDS



GRANITE  
BOLLARDS



RECYCLED  
PLASTIC  
BOLLARDS

- ASF Stainless Steel Bollards  
Pages 2 - 12  
11 Products
  
- ASF Steel Bollards  
Pages 13 - 35  
23 Products
  
- ASF Granite Bollards  
Pages 36 - 43  
8 Products
  
- ASF Recycled Plastic Bollards  
Pages 44 - 47  
4 Products

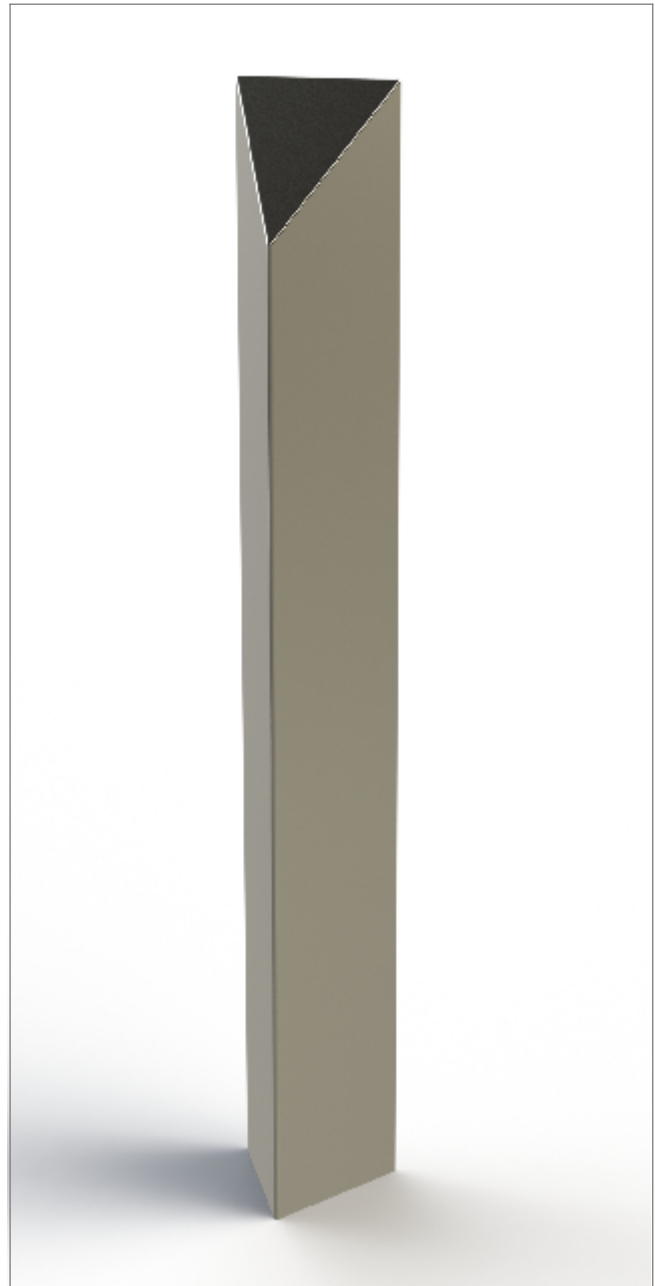
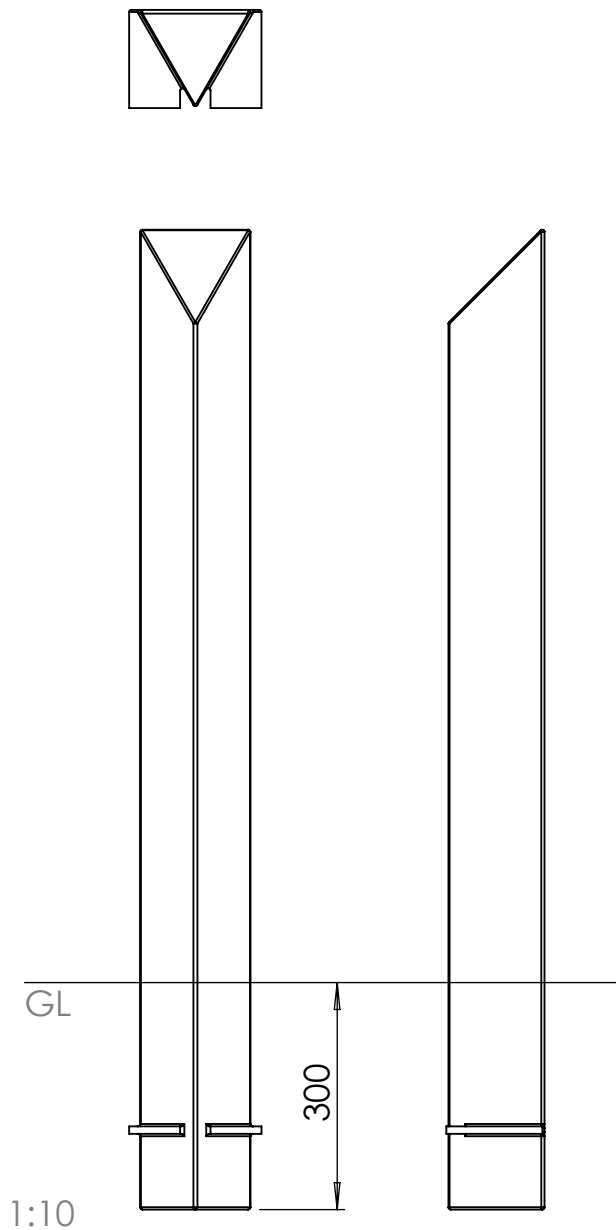

## Bollards | ASF 5000 Triangular Stainless Steel Bollard

**Material:**

Manufactured in either grade 304 or grade 316 stainless steel

**Dimensions:**

Manufactured 150mm wide as standard. Also available 200mm wide.

**Height:**

Bollards are manufactured either 1200mm long (900mm above ground) or 1500mm long (1000mm above ground) All other bollard sizes are available if required

**Standard Finish:**

As standard ASF Stainless Steel Bollards are finished satin brush polished

**Optional Finish:**

Bollards can be bead blasted, bright polished, mirror polished or polyester powder coated

**Ram Raid Options:**

Bollards can be manufactured with inner heavy duty steel inserts or with loose cap for concrete infill

**Visibility Bands:**

Retro reflective self-adhesive visibility bands can be applied. Wet painted and powder coated bands are also available

**Bespoke Options:**

Bollards can be manufactured to base plate fix, or be adapted to accept chains, rails or panels. Bollards can be made to be removable, or to fold down onto the ground or into a trough. Bollards can be adapted to make cycle stands, barriers etc. Door stoppers or door catches can be added.

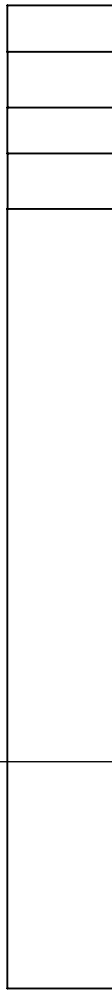
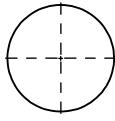

GL

1:10



## Bollards | ASF 5001 Stainless Steel Bollard

**Material:**

Manufactured in either grade 304 or grade 316 stainless steel

**Diameter:**

Manufactured as standard in 114mm diameter. Also available in 76mm, 89mm, 101mm, 129mm, 168mm and 193mm diameters. Other sizes available if required

**Height:**

Bollards are manufactured either 1200mm long (900mm above ground) or 1500mm long (1000mm above ground) All other bollard sizes are available if required

**Standard Finish:**

As standard ASF Stainless Steel Bollards are finished satin brush polished

**Optional Finish:**

Bollards can be bead blasted, bright polished, mirror polished or polyester powder coated

**Ram Raid Options:**

Bollards can be manufactured with inner heavy duty steel inserts or with loose cap for concrete infill

**Visibility Bands:**

Retro reflective self-adhesive visibility bands can be applied. Wet painted and powder coated bands are also available

**Bespoke Options:**

Bollards can be manufactured to base plate fix, or be adapted to accept chains, rails or panels. Bollards can be made to be removable, or to fold down onto the ground or into a trough. Bollards can be adapted to make cycle stands, barriers etc. Door stoppers or door catches can be added.

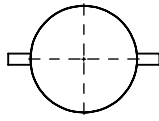

GL

1:10



## Bollards | ASF 5002 Stainless Steel Bollard

**Material:**

Manufactured in either grade 304 or grade 316 stainless steel

**Diameter:**

Manufactured as standard in 114mm diameter. Also available in 76mm, 89mm, 101mm, 129mm, 168mm and 193mm diameters. Other sizes available if required

**Height:**

Bollards are manufactured either 1200mm long (900mm above ground) or 1500mm long (1000mm above ground) All other bollard sizes are available if required

**Standard Finish:**

As standard ASF Stainless Steel Bollards are finished satin brush polished

**Optional Finish:**

Bollards can be bead blasted, bright polished, mirror polished or polyester powder coated

**Ram Raid Options:**

Bollards can be manufactured with inner heavy duty steel inserts or with loose cap for concrete infill

**Visibility Bands:**

Retro reflective self-adhesive visibility bands can be applied. Wet painted and powder coated bands are also available

**Bespoke Options:**

Bollards can be manufactured to base plate fix, or be adapted to accept chains, rails or panels. Bollards can be made to be removable, or to fold down onto the ground or into a trough. Bollards can be adapted to make cycle stands, barriers etc. Door stoppers or door catches can be added.

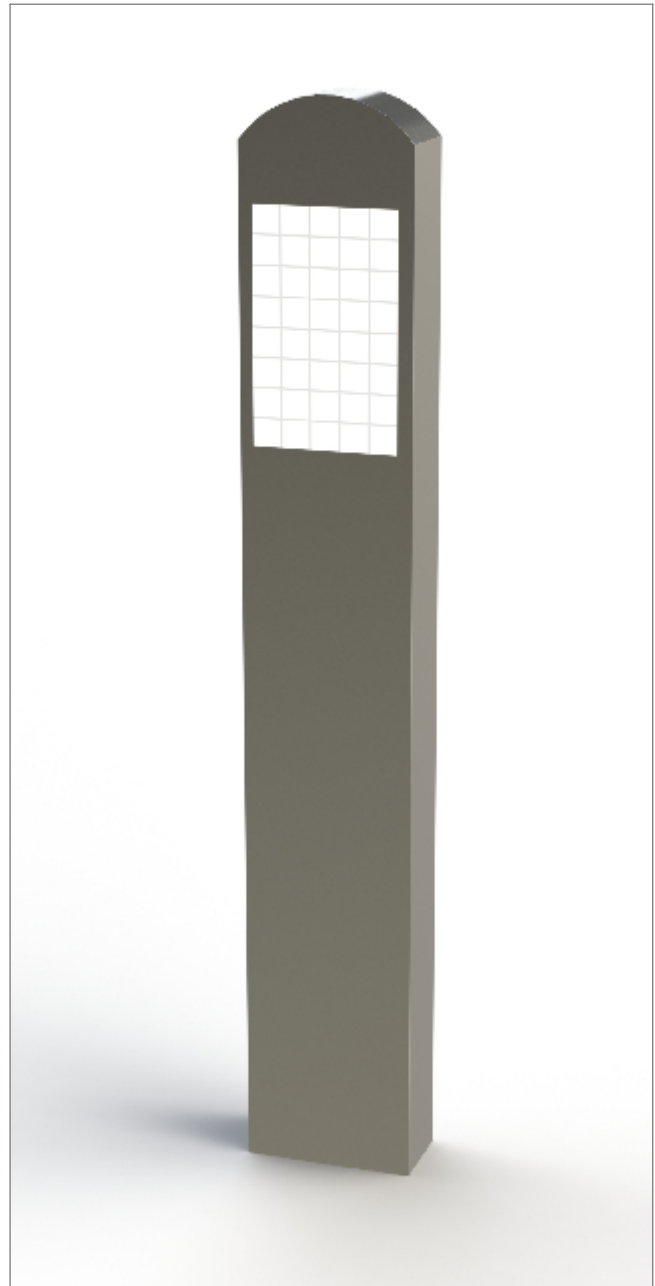
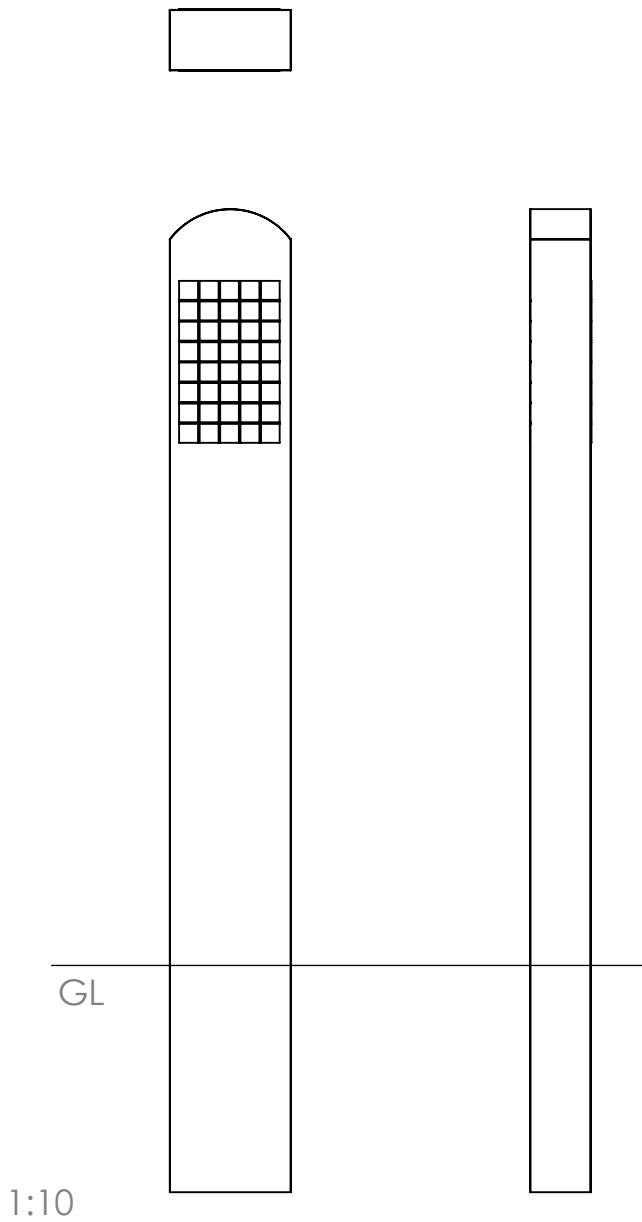

## Bollards | ASF 5003 Rectangular Stainless Steel Bollard

**Material:**

Manufactured in either grade 304 or grade 316 stainless steel

**Dimensions:**

Manufactured in 160mm x 80mm rectangular section stainless steel as standard. This bollard is available in all other sizes of rectangular stainless steel

**Height:**

Bollards are manufactured either 1200mm long (900mm above ground) or 1500mm long (1000mm above ground) All other bollard sizes are available if required

**Standard Finish:**

As standard ASF Stainless Steel Bollards are finished satin brush polished

**Optional Finish:**

Bollards can be bead blasted, bright polished, mirror polished or polyester powder coated

**Ram Raid Options:**

Bollards can be manufactured with inner heavy duty steel inserts or with loose cap for concrete infill

**Visibility Bands:**

Retro reflective self-adhesive visibility bands can be applied. Wet painted and powder coated bands are also available

**Bespoke Options:**

Bollards can be manufactured to base plate fix, or be adapted to accept chains, rails or panels. Bollards can be made to be removable, or to fold down onto the ground or into a trough. Bollards can be adapted to make cycle stands, barriers etc. Door stoppers or door catches can be added.

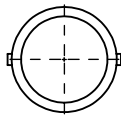

GL

1:10

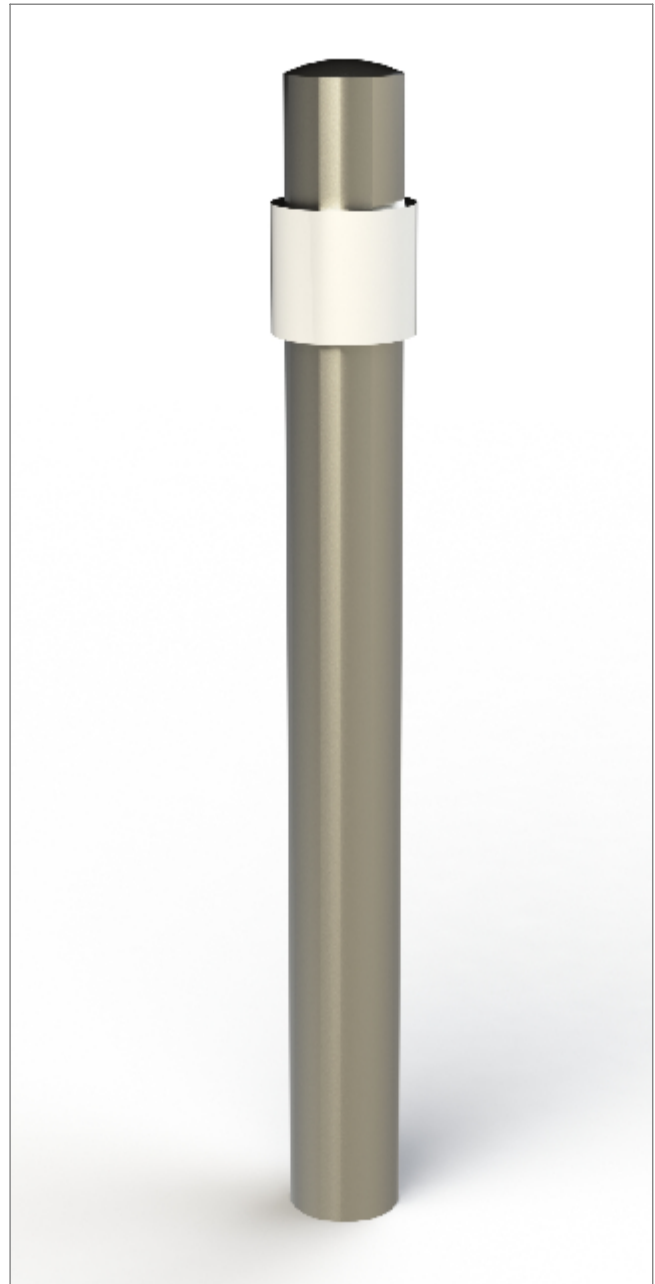

## Bollards | ASF 5004 Stainless Steel Bollard

**Material:**

Manufactured in either grade 304 or grade 316 stainless steel

**Diameter:**

Manufactured as standard in 114mm diameter. Also available in 76mm, 89mm, 101mm, 129mm, 168mm and 193mm diameters. Other sizes available if required

**Height:**

Bollards are manufactured either 1200mm long (900mm above ground) or 1500mm long (1000mm above ground) All other bollard sizes are available if required

**Standard Finish:**

As standard ASF Stainless Steel Bollards are finished satin brush polished

**Optional Finish:**

Bollards can be bead blasted, bright polished, mirror polished or polyester powder coated

**Ram Raid Options:**

Bollards can be manufactured with inner heavy duty steel inserts or with loose cap for concrete infill

**Visibility Bands:**

Retro reflective self-adhesive visibility bands can be applied. Wet painted and powder coated bands are also available

**Bespoke Options:**

Bollards can be manufactured to base plate fix, or be adapted to accept chains, rails or panels. Bollards can be made to be removable, or to fold down onto the ground or into a trough. Bollards can be adapted to make cycle stands, barriers etc. Door stoppers or door catches can be added.

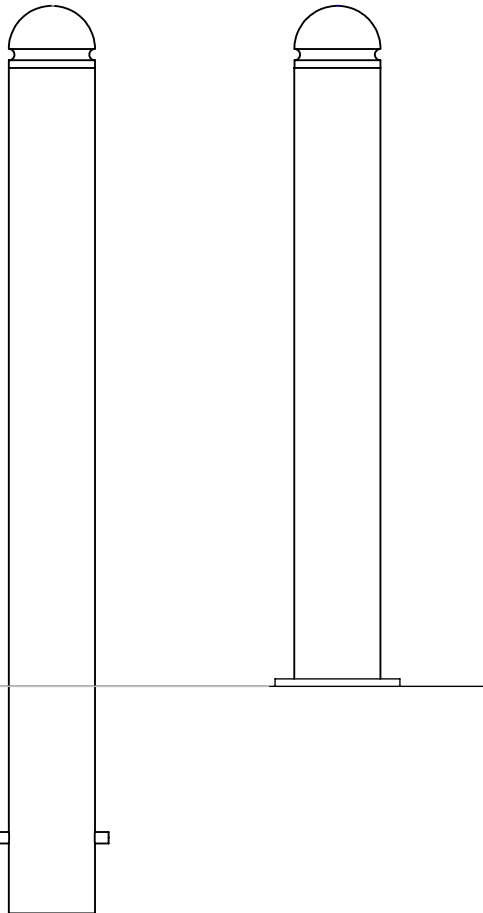
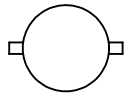

GL

1:10

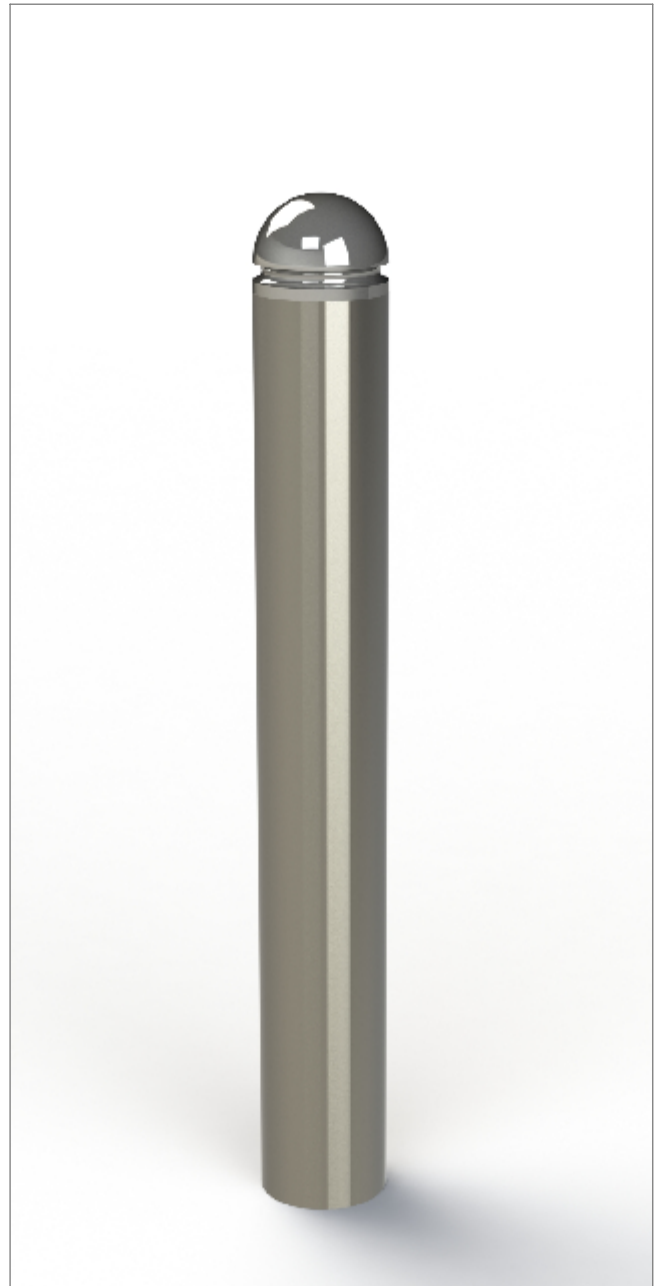

## Bollards | ASF 5005 Stainless Steel Bollard

**Material:**

Manufactured in either grade 304 or grade 316 stainless steel

**Diameter:**

Manufactured as standard in 114mm diameter. Also available in 76mm, 89mm, 101mm, 129mm, 168mm and 193mm diameters. Other sizes available if required

**Height:**

Bollards are manufactured either 1200mm long (900mm above ground) or 1500mm long (1000mm above ground) All other bollard sizes are available if required

**Standard Finish:**

As standard ASF Stainless Steel Bollards are finished satin brush polished

**Optional Finish:**

Bollards can be bead blasted, bright polished, mirror polished or polyester powder coated

**Ram Raid Options:**

Bollards can be manufactured with inner heavy duty steel inserts or with loose cap for concrete infill

**Visibility Bands:**

Retro reflective self-adhesive visibility bands can be applied. Wet painted and powder coated bands are also available

**Bespoke Options:**

Bollards can be manufactured to base plate fix, or be adapted to accept chains, rails or panels. Bollards can be made to be removable, or to fold down onto the ground or into a trough. Bollards can be adapted to make cycle stands, barriers etc. Door stoppers or door catches can be added.



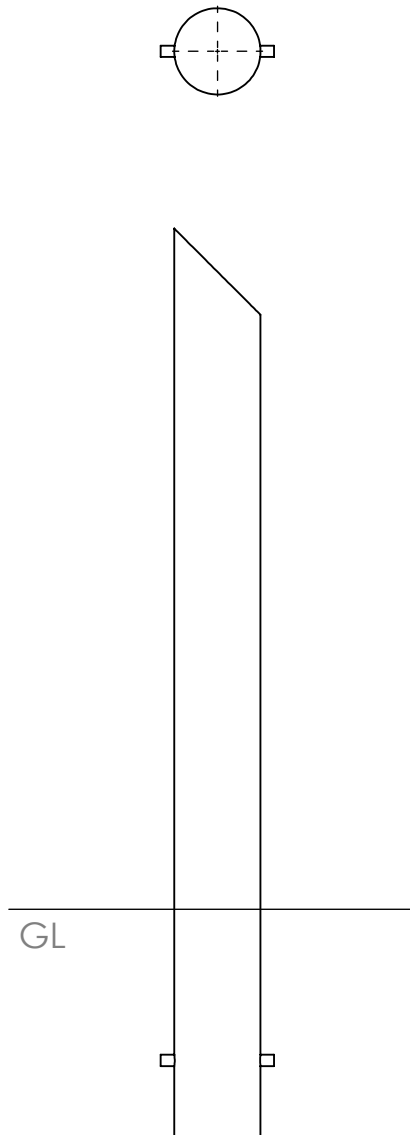

1:10

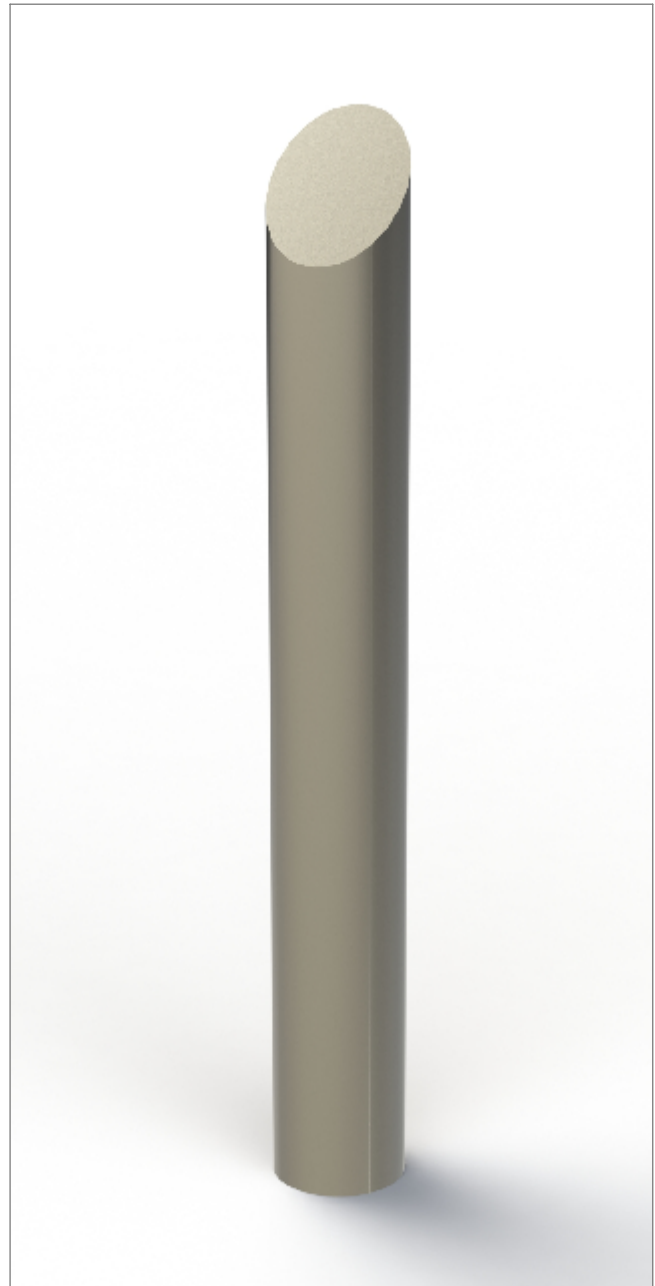

## Bollards | ASF 5006 Stainless Steel Bollard

**Material:**

Manufactured in either grade 304 or grade 316 stainless steel

**Diameter:**

Manufactured as standard in 114mm diameter. Also available in 76mm, 89mm, 101mm, 129mm, 168mm and 193mm diameters. Other sizes available if required

**Height:**

Bollards are manufactured either 1200mm long (900mm above ground) or 1500mm long (1000mm above ground) All other bollard sizes are available if required

**Standard Finish:**

As standard ASF Stainless Steel Bollards are finished satin brush polished

**Optional Finish:**

Bollards can be bead blasted, bright polished, mirror polished or polyester powder coated

**Ram Raid Options:**

Bollards can be manufactured with inner heavy duty steel inserts or with loose cap for concrete infill

**Visibility Bands:**

Retro reflective self-adhesive visibility bands can be applied. Wet painted and powder coated bands are also available

**Bespoke Options:**

Bollards can be manufactured to base plate fix, or be adapted to accept chains, rails or panels. Bollards can be made to be removable, or to fold down onto the ground or into a trough. Bollards can be adapted to make cycle stands, barriers etc. Door stoppers or door catches can be added.

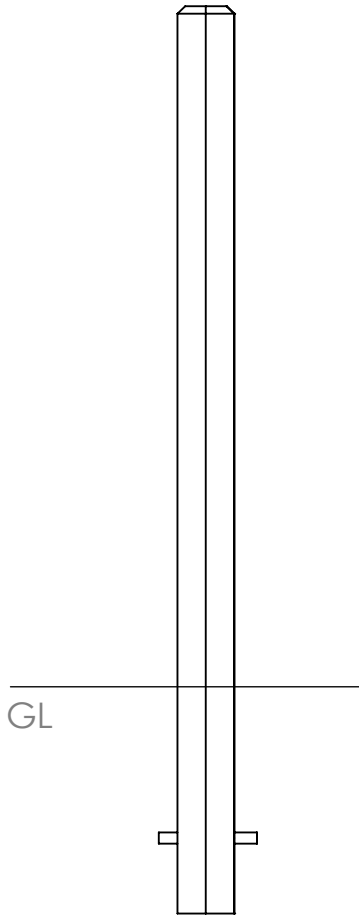
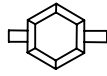

1:10

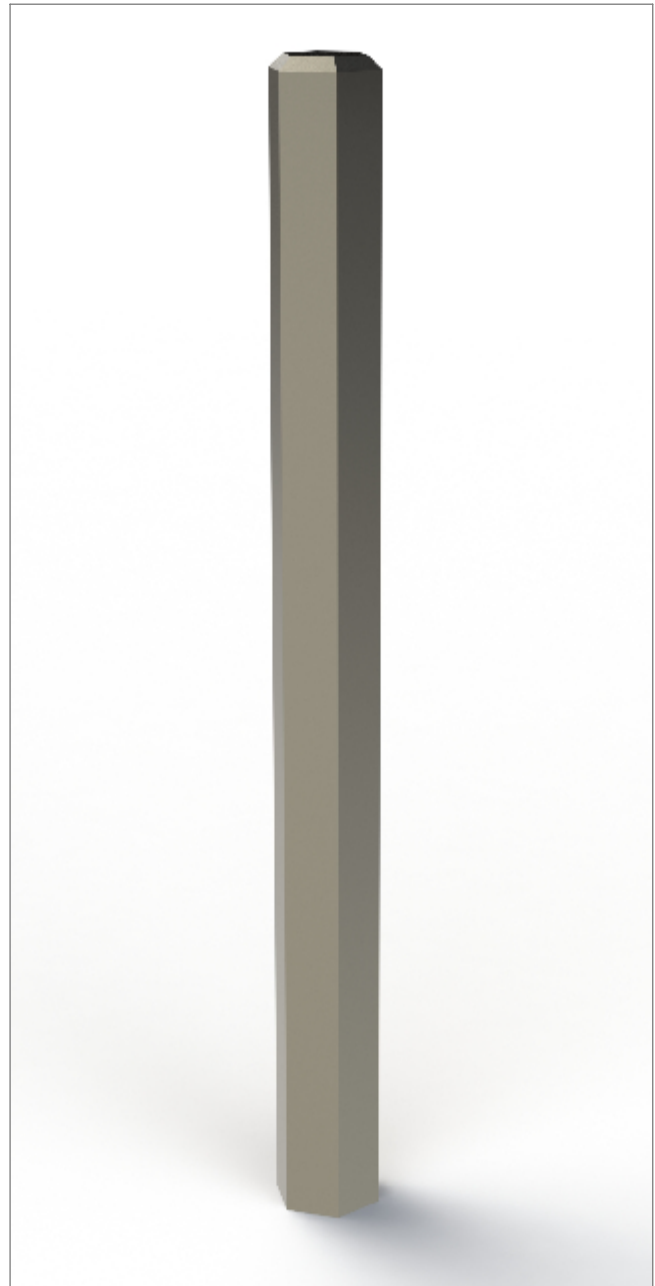

## Bollards | ASF 5007 Hexagonal Stainless Steel Bollard

**Material:**

Manufactured in either grade 304 or grade 316 stainless steel

**Dimensions:**

This bollard is available in either a 150mm section or a 200mm section

**Height:**

Bollards are manufactured either 1200mm long (900mm above ground) or 1500mm long (1000mm above ground) All other bollard sizes are available if required

**Standard Finish:**

As standard ASF Stainless Steel Bollards are finished satin brush polished

**Optional Finish:**

Bollards can be bead blasted, bright polished, mirror polished or polyester powder coated

**Ram Raid Options:**

Bollards can be manufactured with inner heavy duty steel inserts or with loose cap for concrete infill

**Visibility Bands:**

Retro reflective self-adhesive visibility bands can be applied. Wet painted and powder coated bands are also available

**Bespoke Options:**

Bollards can be manufactured to base plate fix, or be adapted to accept chains, rails or panels. Bollards can be made to be removable, or to fold down onto the ground or into a trough. Bollards can be adapted to make cycle stands, barriers etc. Door stoppers or door catches can be added.

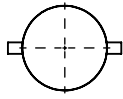

GL

1:10

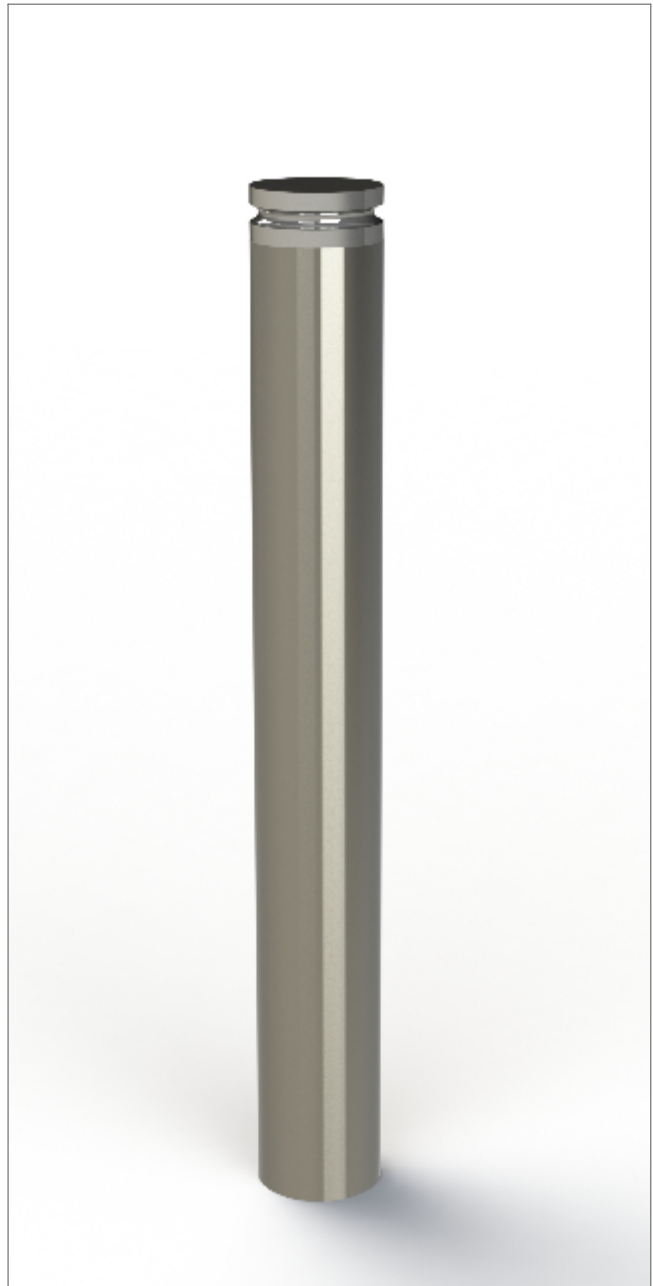

## Bollards | ASF 5008 Stainless Steel Bollard

**Material:**

Manufactured in either grade 304 or grade 316 stainless steel

**Diameter:**

Manufactured as standard in 114mm diameter. Also available in 76mm, 89mm, 101mm, 129mm and 168mm diameters. Other sizes available if required

**Height:**

Bollards are manufactured either 1200mm long (900mm above ground) or 1500mm long (1000mm above ground) All other bollard sizes are available if required

**Standard Finish:**

As standard ASF Stainless Steel Bollards are finished satin brush polished

**Optional Finish:**

Bollards can be bead blasted, bright polished, mirror polished or polyester powder coated

**Ram Raid Options:**

Bollards can be manufactured with inner heavy duty steel inserts or with loose cap for concrete infill

**Visibility Bands:**

Retro reflective self-adhesive visibility bands can be applied. Wet painted and powder coated bands are also available

**Bespoke Options:**

Bollards can be manufactured to base plate fix, or be adapted to accept chains, rails or panels. Bollards can be made to be removable, or to fold down onto the ground or into a trough. Bollards can be adapted to make cycle stands, barriers etc. Door stoppers or door catches can be added.

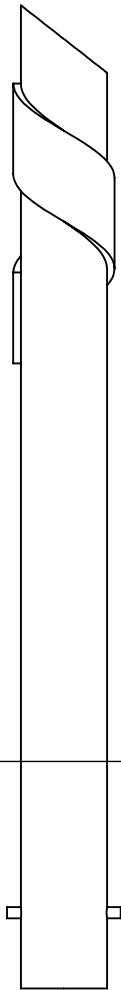
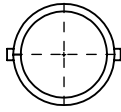

1:10

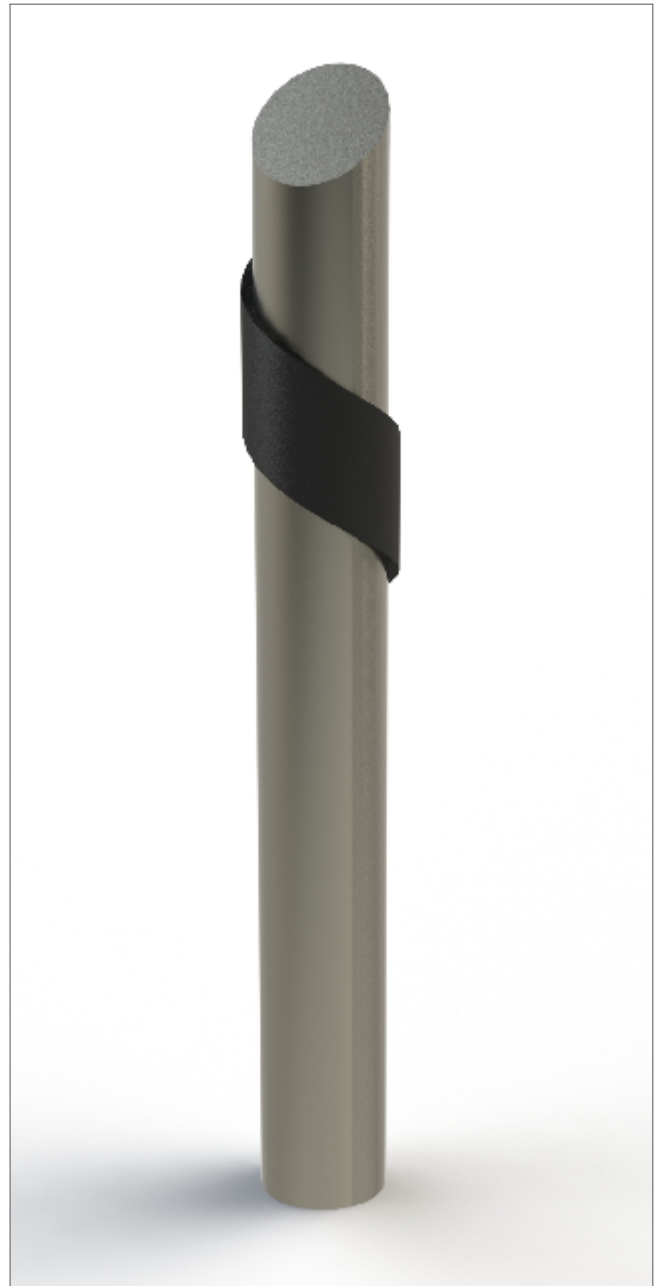

## Bollards | ASF 5009 Stainless Steel Bollard

**Material:**

Manufactured in either grade 304 or grade 316 stainless steel

**Diameter:**

Manufactured as standard in 114mm diameter. Also available in 76mm, 89mm, 101mm, 129mm and 168mm diameters. Other sizes available if required

**Height:**

Bollards are manufactured either 1200mm long (900mm above ground) or 1500mm long (1000mm above ground) All other bollard sizes are available if required

**Standard Finish:**

As standard ASF Stainless Steel Bollards are finished satin brush polished

**Optional Finish:**

Bollards can be bead blasted, bright polished, mirror polished or polyester powder coated

**Ram Raid Options:**

Bollards can be manufactured with inner heavy duty steel inserts or with loose cap for concrete infill

**Visibility Bands:**

Retro reflective self-adhesive visibility bands can be applied. Wet painted and powder coated bands are also available

**Bespoke Options:**

Bollards can be manufactured to base plate fix, or be adapted to accept chains, rails or panels. Bollards can be made to be removable, or to fold down onto the ground or into a trough. Bollards can be adapted to make cycle stands, barriers etc. Door stoppers or door catches can be added.

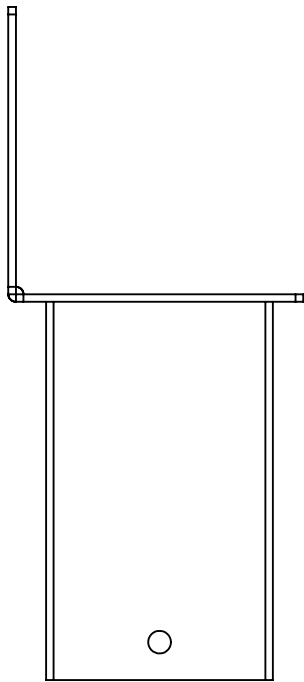
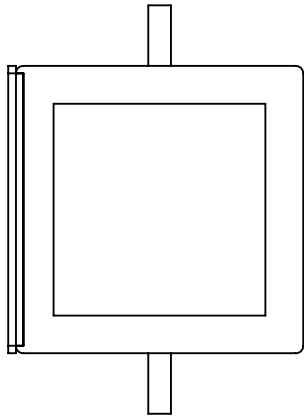

1:5

## Bollards | ASF 652 Bollard Ground Socket

**Material:**

Ground Sockets are manufactured to match the bollard material. Galvanised mild steel is used for cast iron, cast aluminium and steel bollards whilst stainless steel is used for stainless steel bollards.

**Finish:**

Ground sockets are finished to match bollards. All mild steel sockets are galvanised and stainless steel sockets are polished to match the bollards. Sockets can be painted if required.

**Options:**

Sockets can be manufactured to suit most bollard styles and dimensions are dictated by the bollard root dimensions. Socket lids can have anti slip surfaces if required.

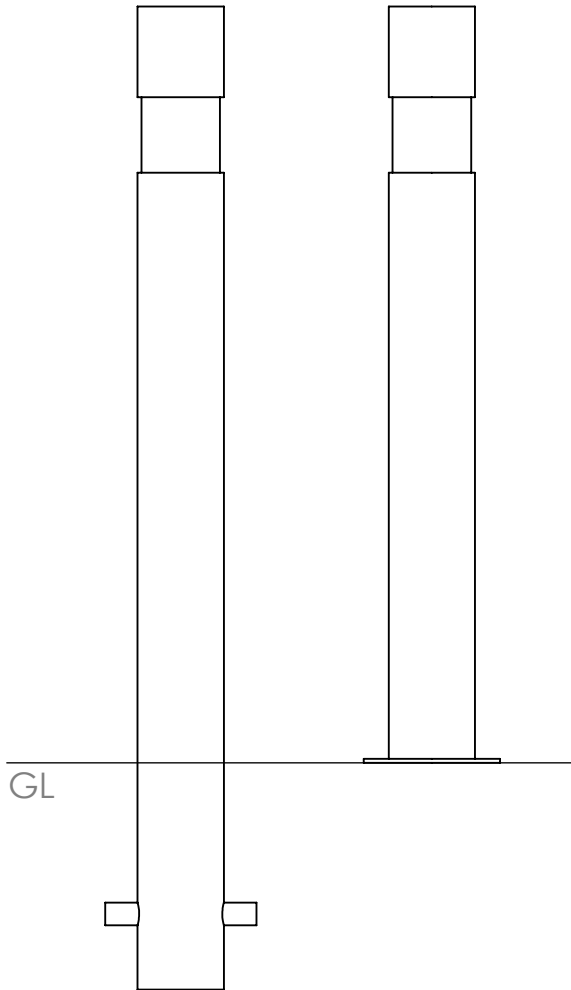

1:10

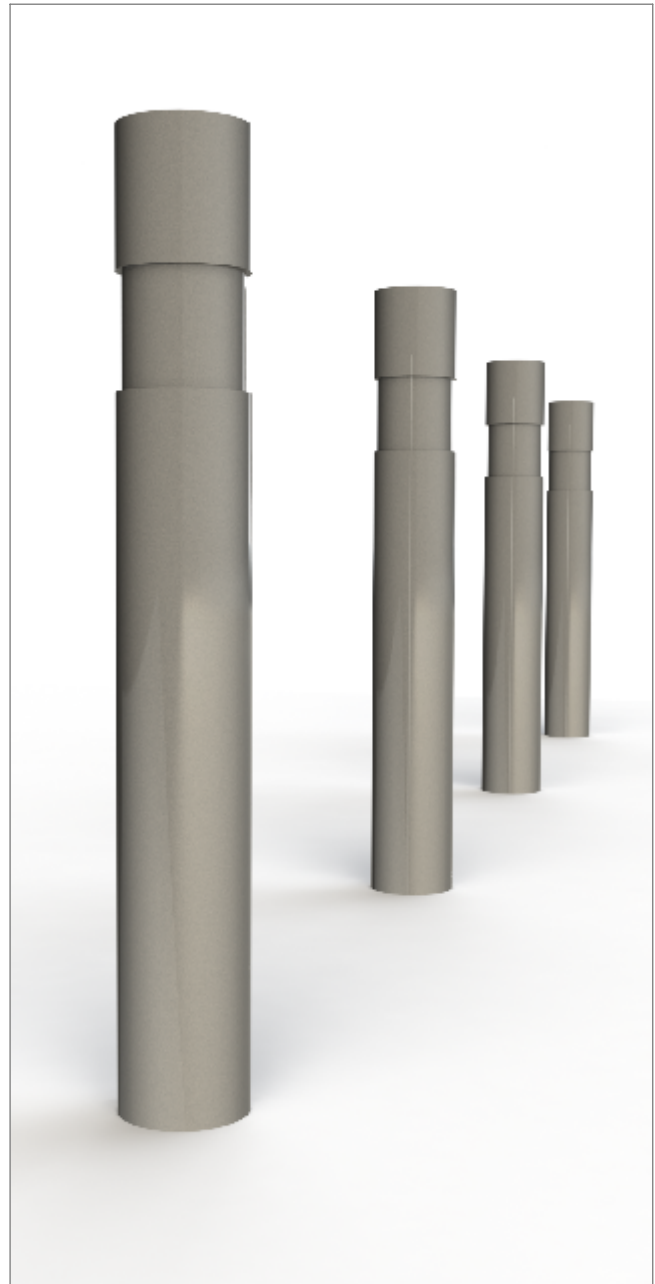

## Bollards | ASF 001 Steel Bollard

**Material:**

Manufactured in 275 carbon steel from recycled sources

**Diameter:**

Manufactured as standard in 114mm diameter. Also available in 76mm, 89mm, 101mm, 129mm, 168mm and 193mm diameters. Other sizes available if required

**Height:**

Bollards are manufactured either 1200mm long (900mm above ground) or 1500mm long (1000mm above ground) All other bollard sizes are available if required

**Standard Finish:**

As standard ASF Steel Bollards are finished hot dip galvanised

**Optional Finish:**

Bollards can be polyester powder coated, nylon coated or wet painted

**Ram Raid Options:**

Bollards can be manufactured with inner heavy duty steel inserts or with loose cap for concrete infill

**Visibility Bands:**

Retro reflective self-adhesive visibility bands can be applied. Wet painted and powder coated bands are also available

**Bespoke Options:**

Bollards can be manufactured to base plate fix, or be adapted to accept chains, rails or panels. Bollards can be made to be removable, or to fold down onto the ground or into a trough. Bollards can be adapted to make cycle stands, barriers etc. Door stoppers or door catches can be added.

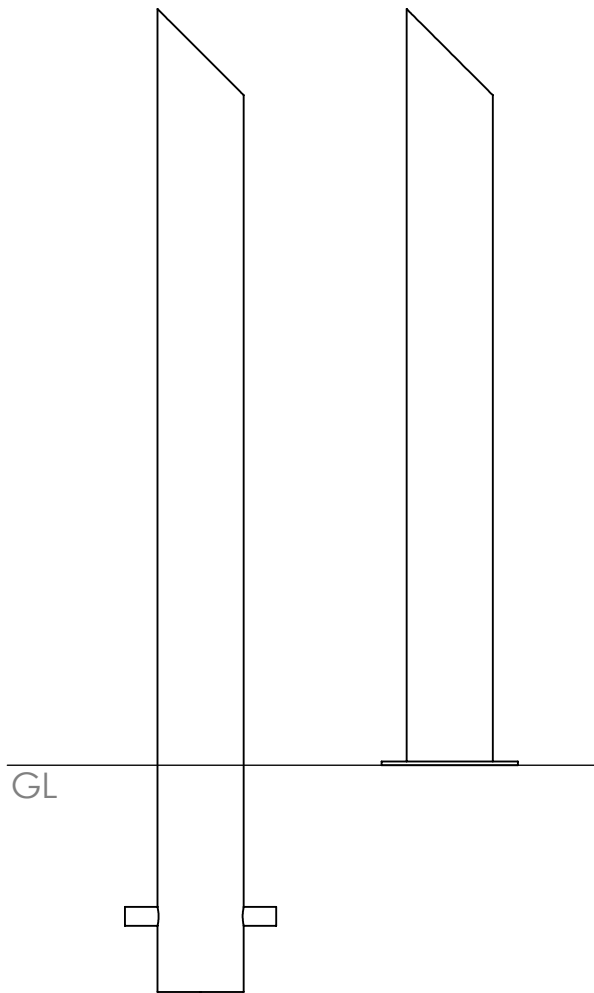

1:10



## Bollards | ASF 002 Steel Bollard

**Material:**

Manufactured in 275 carbon steel from recycled sources

**Diameter:**

Manufactured as standard in 114mm diameter. Also available in 76mm, 89mm, 101mm, 129mm, 168mm and 193mm diameters. Other sizes available if required

**Height:**

Bollards are manufactured either 1200mm long (900mm above ground) or 1500mm long (1000mm above ground) All other bollard sizes are available if required

**Standard Finish:**

As standard ASF Steel Bollards are finished hot dip galvanised

**Optional Finish:**

Bollards can be polyester powder coated, nylon coated or wet painted

**Ram Raid Options:**

Bollards can be manufactured with inner heavy duty steel inserts or with loose cap for concrete infill

**Visibility Bands:**

Retro reflective self-adhesive visibility bands can be applied. Wet painted and powder coated bands are also available

**Bespoke Options:**

Bollards can be manufactured to base plate fix, or be adapted to accept chains, rails or panels. Bollards can be made to be removable, or to fold down onto the ground or into a trough. Bollards can be adapted to make cycle stands, barriers etc. Door stoppers or door catches can be added.

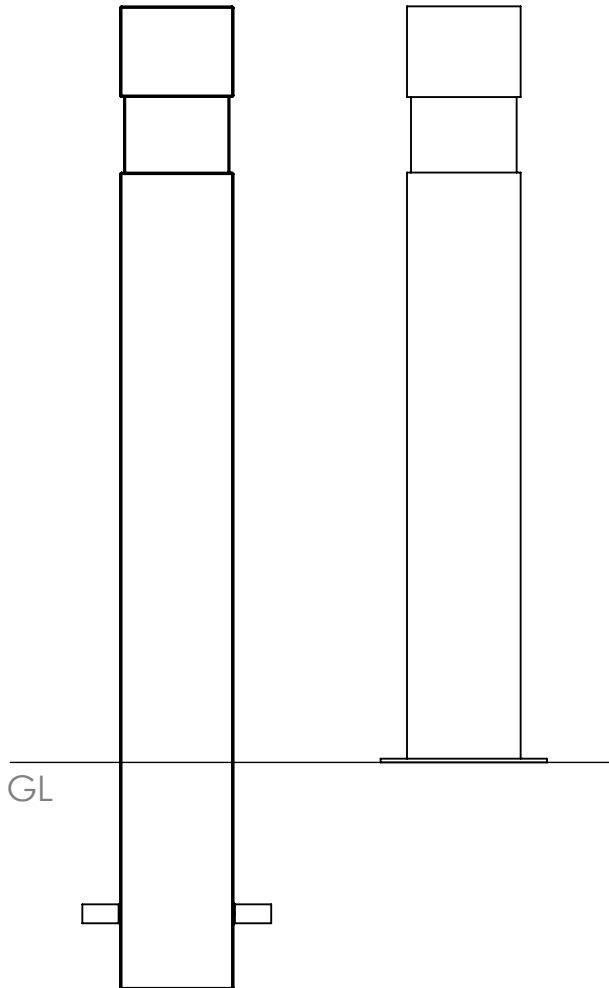

1:10



## Bollards | ASF 003 Square Steel Bollard

**Material:**

Manufactured in 275 carbon steel from recycled sources

**Dimension:**

As standard ASF square steel bollards are manufactured 150mmSQ Also available in 100mm and 200mmSQ. Other sizes available if required

**Height:**

Bollards are manufactured either 1200mm long (900mm above ground) or 1500mm long (1000mm above ground) All other bollard sizes are available if required

**Standard Finish:**

As standard ASF Steel Bollards are finished hot dip galvanised

**Optional Finish:**

Bollards can be polyester powder coated, nylon coated or wet painted

**Ram Raid Options:**

Bollards can be manufactured with inner heavy duty steel inserts or with loose cap for concrete infill

**Visibility Bands:**

Retro reflective self-adhesive visibility bands can be applied. Wet painted and powder coated bands are also available

**Bespoke Options:**

Bollards can be manufactured to base plate fix, or be adapted to accept chains, rails or panels. Bollards can be made to be removable, or to fold down onto the ground or into a trough. Bollards can be adapted to make cycle stands, barriers etc. Door stoppers or door catches can be added.



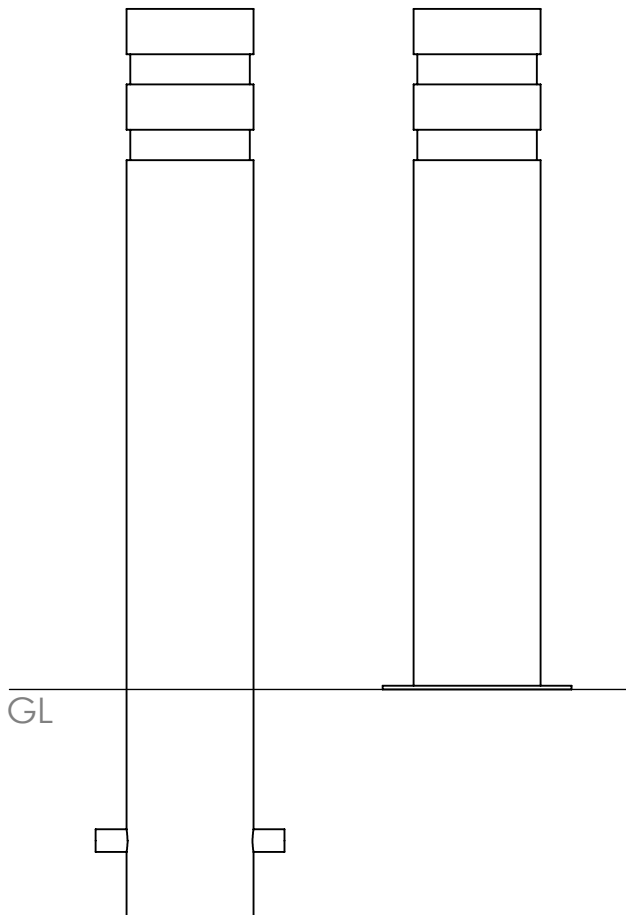

1:10



## Bollards | ASF 004 Steel Bollard

**Material:**

Manufactured in 275 carbon steel from recycled sources

**Diameter:**

Manufactured as standard in 114mm diameter. Also available in 76mm, 89mm, 101mm, 129mm, 168mm and 193mm diameters. Other sizes available if required

**Height:**

Bollards are manufactured either 1200mm long (900mm above ground) or 1500mm long (1000mm above ground) All other bollard sizes are available if required

**Standard Finish:**

As standard ASF Steel Bollards are finished hot dip galvanised

**Optional Finish:**

Bollards can be polyester powder coated, nylon coated or wet painted

**Ram Raid Options:**

Bollards can be manufactured with inner heavy duty steel inserts or with loose cap for concrete infill

**Visibility Bands:**

Retro reflective self-adhesive visibility bands can be applied. Wet painted and powder coated bands are also available

**Bespoke Options:**

Bollards can be manufactured to base plate fix, or be adapted to accept chains, rails or panels. Bollards can be made to be removable, or to fold down onto the ground or into a trough. Bollards can be adapted to make cycle stands, barriers etc. Door stoppers or door catches can be added.

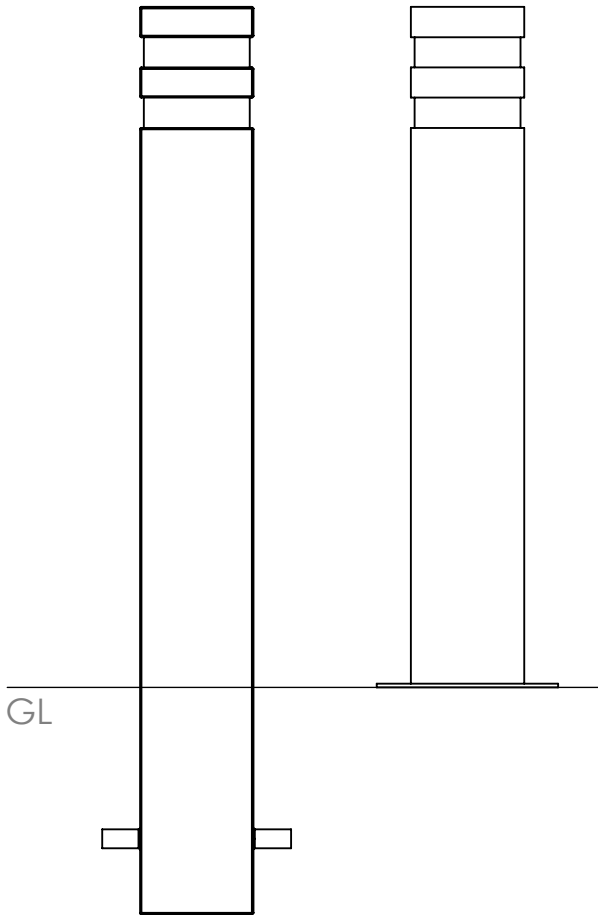

1:10



## Bollards | ASF 005 Square Steel Bollard

**Material:**

Manufactured in 275 carbon steel from recycled sources

**Dimension:**

As standard ASF square steel bollards are manufactured 150mmSQ Also available in 100mm and 200mmSQ. Other sizes available if required

**Height:**

Bollards are manufactured either 1200mm long (900mm above ground) or 1500mm long (1000mm above ground) All other bollard sizes are available if required

**Standard Finish:**

As standard ASF Steel Bollards are finished hot dip galvanised

**Optional Finish:**

Bollards can be polyester powder coated, nylon coated or wet painted

**Ram Raid Options:**

Bollards can be manufactured with inner heavy duty steel inserts or with loose cap for concrete infill

**Visibility Bands:**

Retro reflective self-adhesive visibility bands can be applied. Wet painted and powder coated bands are also available

**Bespoke Options:**

Bollards can be manufactured to base plate fix, or be adapted to accept chains, rails or panels. Bollards can be made to be removable, or to fold down onto the ground or into a trough. Bollards can be adapted to make cycle stands, barriers etc. Door stoppers or door catches can be added.

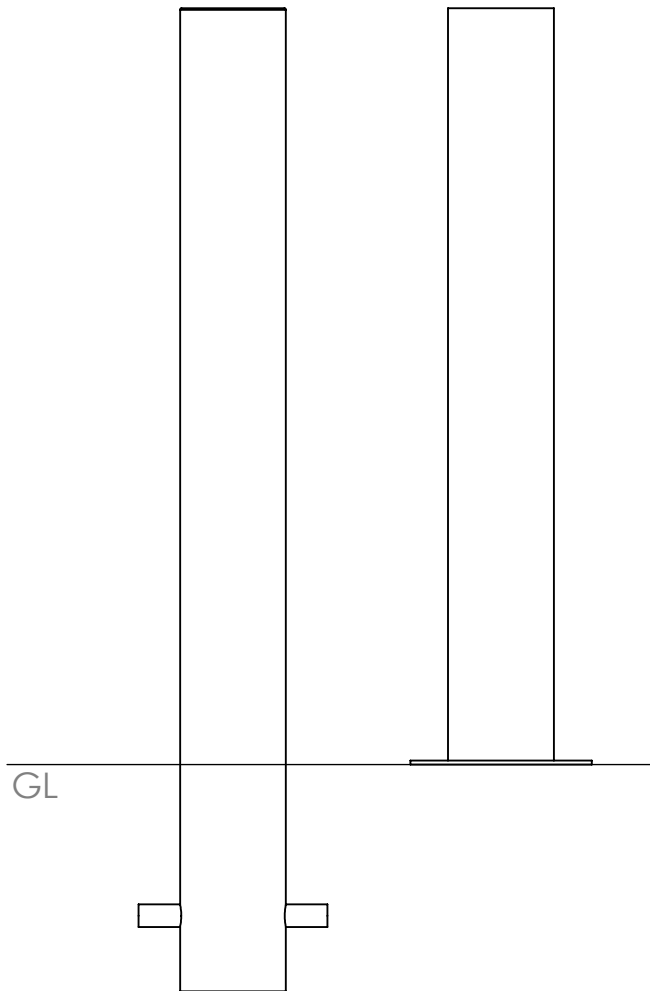

1:10

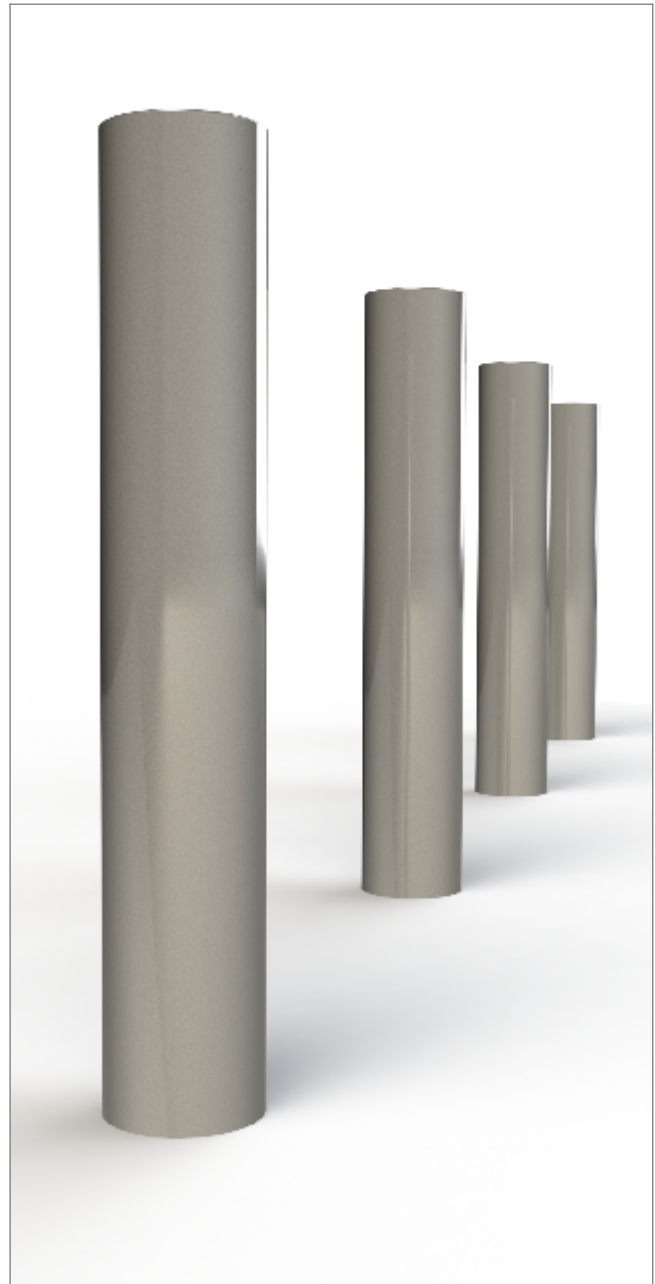

## Bollards | ASF 006 Steel Bollard

**Material:**

Manufactured in 275 carbon steel from recycled sources

**Diameter:**

Manufactured as standard in 114mm diameter. Also available in 76mm, 89mm, 101mm, 129mm, 168mm and 193mm diameters. Other sizes available if required

**Height:**

Bollards are manufactured either 1200mm long (900mm above ground) or 1500mm long (1000mm above ground) All other bollard sizes are available if required

**Standard Finish:**

As standard ASF Steel Bollards are finished hot dip galvanised

**Optional Finish:**

Bollards can be polyester powder coated, nylon coated or wet painted

**Ram Raid Options:**

Bollards can be manufactured with inner heavy duty steel inserts or with loose cap for concrete infill

**Visibility Bands:**

Retro reflective self-adhesive visibility bands can be applied. Wet painted and powder coated bands are also available

**Bespoke Options:**

Bollards can be manufactured to base plate fix, or be adapted to accept chains, rails or panels. Bollards can be made to be removable, or to fold down onto the ground or into a trough. Bollards can be adapted to make cycle stands, barriers etc. Door stoppers or door catches can be added.

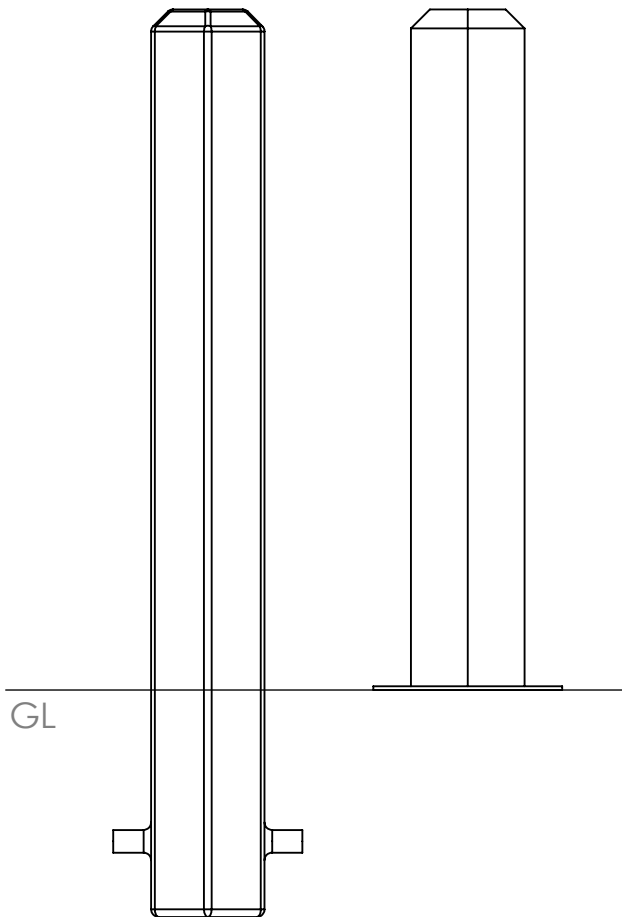

1:10

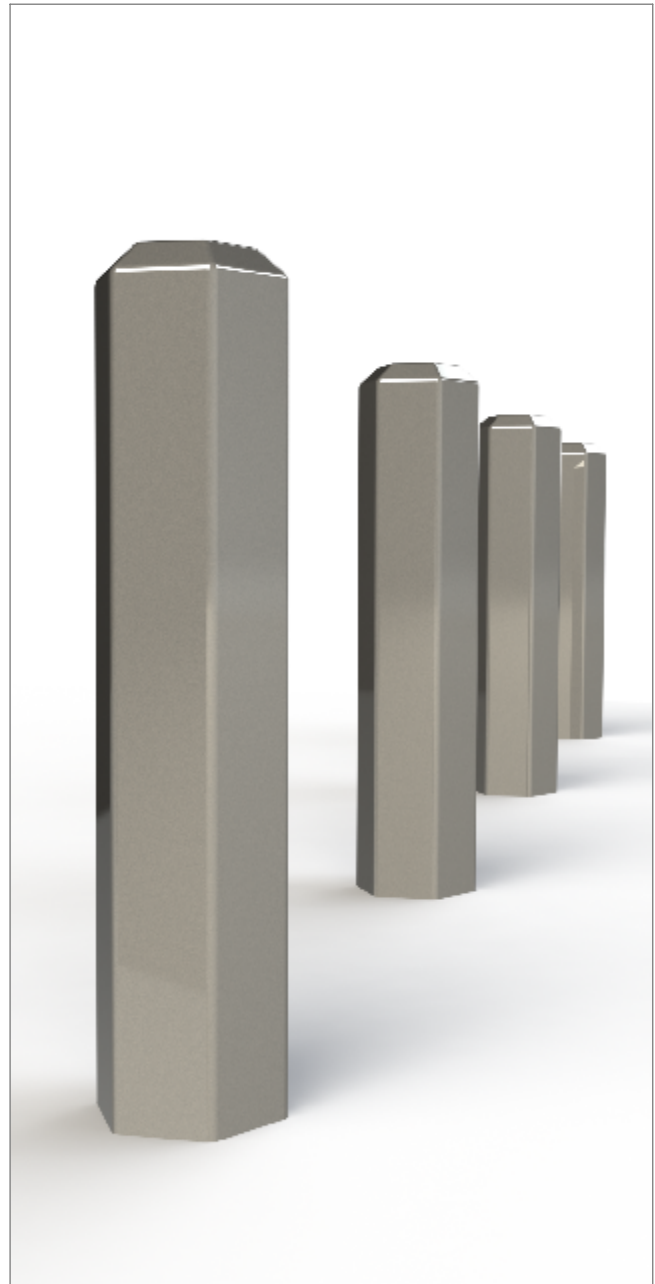

## Bollards | ASF 007 Hexagonal Steel Bollard

**Material:**

Manufactured in 275 carbon steel from recycled sources

**Dimension:**

150mm section. Also available in 200mm section

**Height:**

Bollards are manufactured either 1200mm long (900mm above ground) or 1500mm long (1000mm above ground) All other bollard sizes are available if required

**Standard Finish:**

Acid etched, zinc rich primed and polyester powder coated

**Optional Finish:**

Bollards can be polyester powder coated, nylon coated or wet painted

**Ram Raid Options:**

Bollards can be manufactured with inner heavy duty steel inserts or with loose cap for concrete infill

**Visibility Bands:**

Retro reflective self-adhesive visibility bands can be applied. Wet painted and powder coated bands are also available

**Bespoke Options:**

Bollards can be manufactured to base plate fix, or be adapted to accept chains, rails or panels. Bollards can be made to be removable, or to fold down onto the ground or into a trough. Bollards can be adapted to make cycle stands, barriers etc. Door stoppers or door catches can be added.

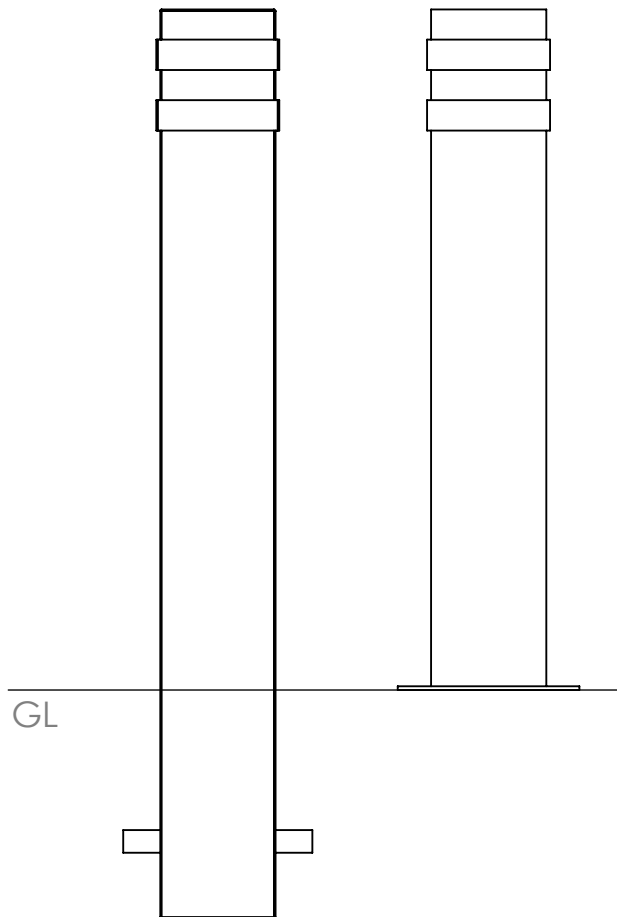

1:10

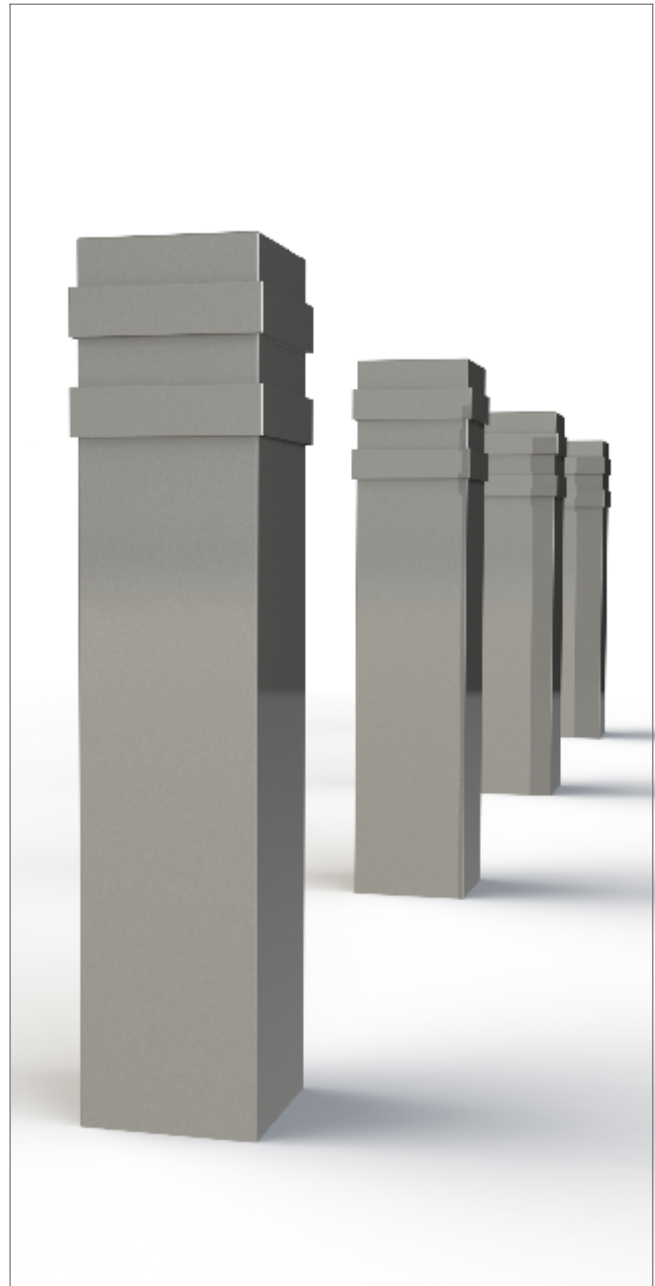

## Bollards | ASF 008 Square Steel Bollard

**Material:**

Manufactured in 275 carbon steel from recycled sources

**Dimension:**

As standard ASF square steel bollards are manufactured 150mmSQ Also available in 100mm and 200mmSQ. Other sizes available if required

**Height:**

Bollards are manufactured either 1200mm long (900mm above ground) or 1500mm long (1000mm above ground) All other bollard sizes are available if required

**Standard Finish:**

As standard ASF Steel Bollards are finished hot dip galvanised

**Optional Finish:**

Bollards can be polyester powder coated, nylon coated or wet painted

**Ram Raid Options:**

Bollards can be manufactured with inner heavy duty steel inserts or with loose cap for concrete infill

**Visibility Bands:**

Retro reflective self-adhesive visibility bands can be applied. Wet painted and powder coated bands are also available

**Bespoke Options:**

Bollards can be manufactured to base plate fix, or be adapted to accept chains, rails or panels. Bollards can be made to be removable, or to fold down onto the ground or into a trough. Bollards can be adapted to make cycle stands, barriers etc. Door stoppers or door catches can be added.

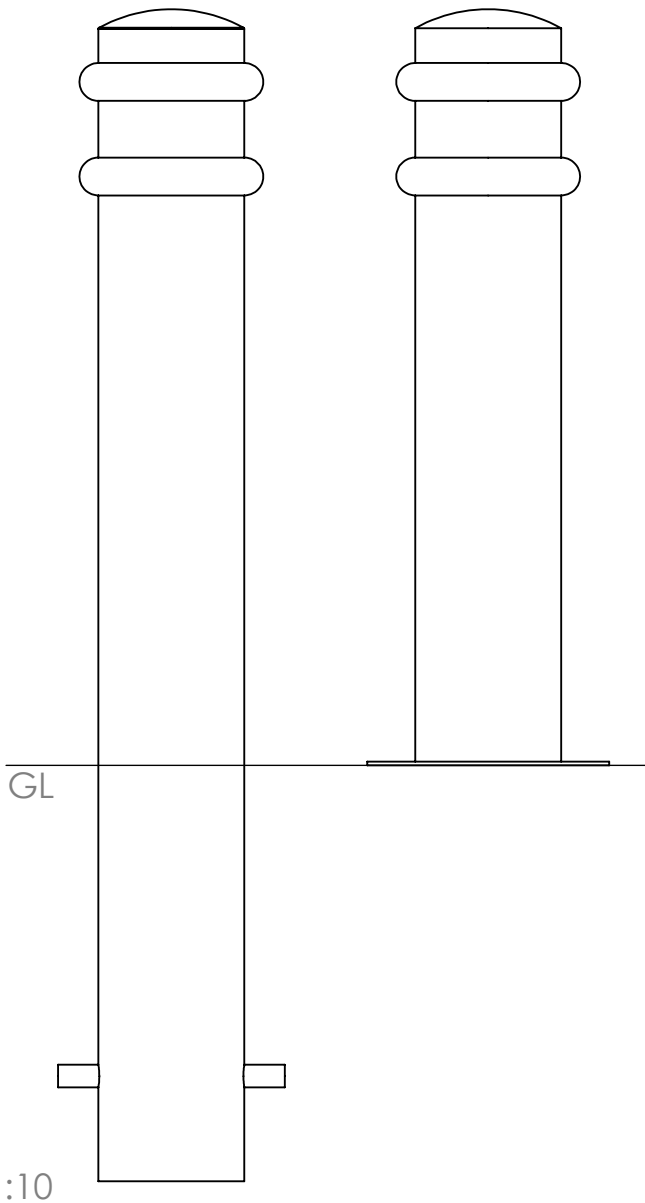

## Bollards | ASF 009 Steel Bollard

**Material:**

Manufactured in 275 carbon steel from recycled sources

**Diameter:**

Manufactured as standard in 114mm diameter. Also available in 76mm, 89mm, 101mm, 129mm, 168mm and 193mm diameters. Other sizes available if required

**Height:**

Bollards are manufactured either 1200mm long (900mm above ground) or 1500mm long (1000mm above ground) All other bollard sizes are available if required

**Standard Finish:**

As standard ASF Steel Bollards are finished hot dip galvanised

**Optional Finish:**

Bollards can be polyester powder coated, nylon coated or wet painted

**Ram Raid Options:**

Bollards can be manufactured with inner heavy duty steel inserts or with loose cap for concrete infill

**Visibility Bands:**

Retro reflective self-adhesive visibility bands can be applied. Wet painted and powder coated bands are also available

**Bespoke Options:**

Bollards can be manufactured to base plate fix, or be adapted to accept chains, rails or panels. Bollards can be made to be removable, or to fold down onto the ground or into a trough. Bollards can be adapted to make cycle stands, barriers etc. Door stoppers or door catches can be added.

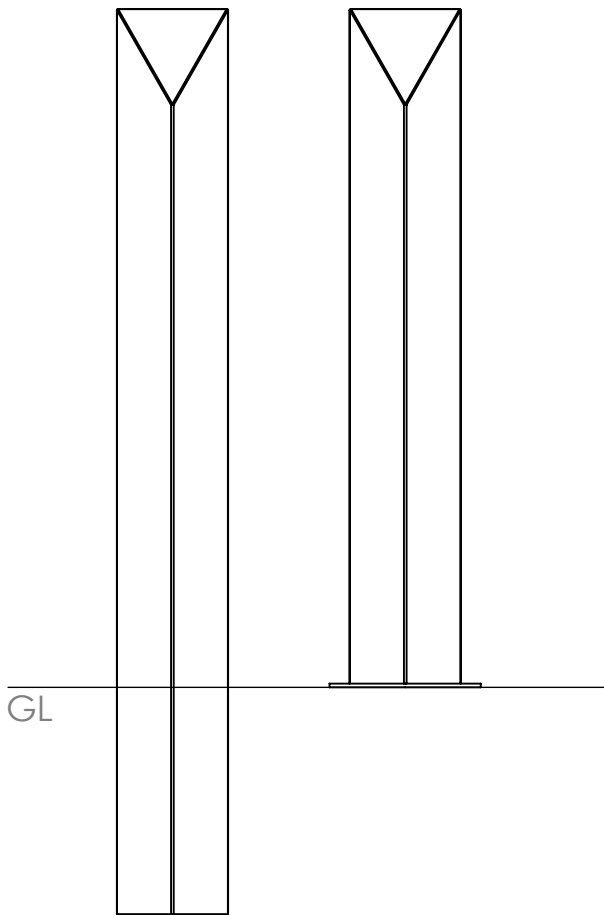

1:10



## Bollards | ASF 010 Triangular Steel Bollard

**Material:**

Manufactured in 275 carbon steel from recycled sources

**Dimensions:**

150mm wide. Also available 200mm wide

**Height:**

Bollards are manufactured either 1200mm long (900mm above ground) or 1500mm long (1000mm above ground) All other bollard sizes are available if required

**Standard Finish:**

Acid etched, zinc rich primed and polyester powder coated

**Ram Raid Options:**

Bollards can be manufactured with inner heavy duty steel inserts or with loose cap for concrete infill

**Visibility Bands:**

Retro reflective self-adhesive visibility bands can be applied. Wet painted and powder coated bands are also available

**Bespoke Options:**

Bollards can be manufactured to base plate fix, or be adapted to accept chains, rails or panels. Bollards can be made to be removable, or to fold down onto the ground or into a trough. Bollards can be adapted to make cycle stands, barriers etc. Door stoppers or door catches can be added.

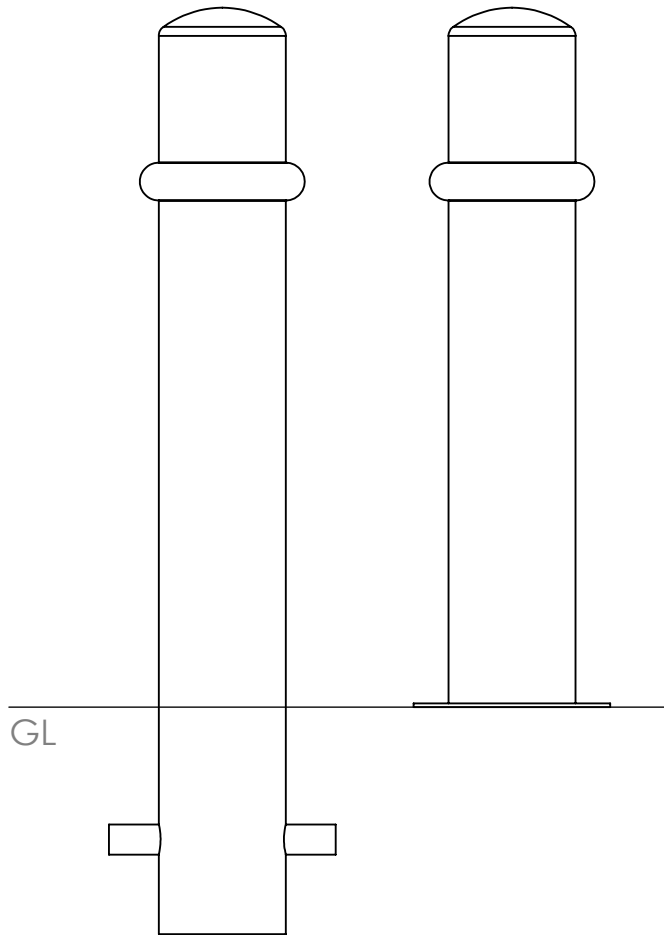

1:10



## Bollards | ASF 011 Steel Bollard

**Material:**

Manufactured in 275 carbon steel from recycled sources

**Diameter:**

Manufactured as standard in 114mm diameter. Also available in 76mm, 89mm, 101mm, 129mm, 168mm and 193mm diameters. Other sizes available if required

**Height:**

Bollards are manufactured either 1200mm long (900mm above ground) or 1500mm long (1000mm above ground) All other bollard sizes are available if required

**Standard Finish:**

As standard ASF Steel Bollards are finished hot dip galvanised

**Optional Finish:**

Bollards can be polyester powder coated, nylon coated or wet painted

**Ram Raid Options:**

Bollards can be manufactured with inner heavy duty steel inserts or with loose cap for concrete infill

**Visibility Bands:**

Retro reflective self-adhesive visibility bands can be applied. Wet painted and powder coated bands are also available

**Bespoke Options:**

Bollards can be manufactured to base plate fix, or be adapted to accept chains, rails or panels. Bollards can be made to be removable, or to fold down onto the ground or into a trough. Bollards can be adapted to make cycle stands, barriers etc. Door stoppers or door catches can be added.



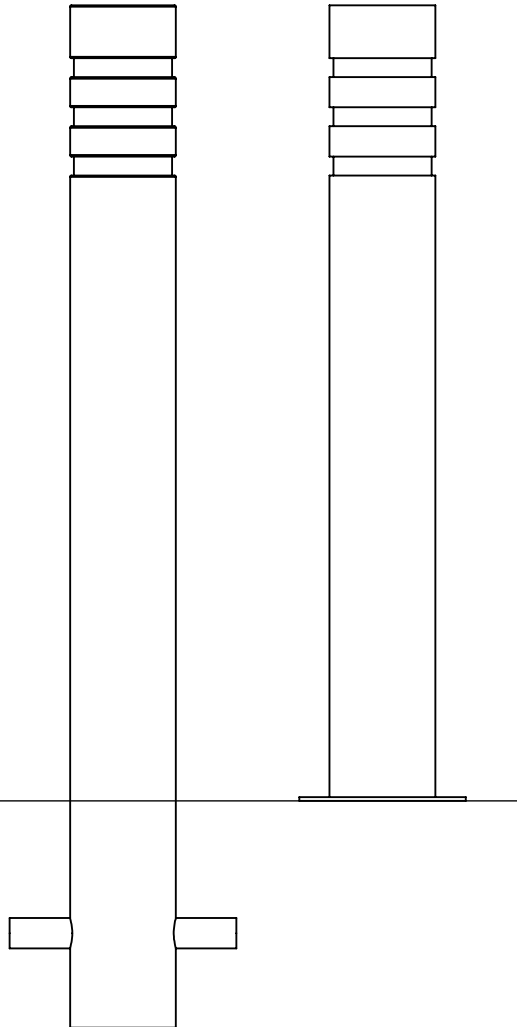

1:10



## Bollards | ASF 012 Steel Bollard

**Material:**

Manufactured in 275 carbon steel from recycled sources

**Diameter:**

Manufactured as standard in 114mm diameter. Also available in 76mm, 89mm, 101mm, 129mm, 168mm and 193mm diameters. Other sizes available if required

**Height:**

Bollards are manufactured either 1200mm long (900mm above ground) or 1500mm long (1000mm above ground) All other bollard sizes are available if required

**Standard Finish:**

As standard ASF Steel Bollards are finished hot dip galvanised

**Optional Finish:**

Bollards can be polyester powder coated, nylon coated or wet painted

**Ram Raid Options:**

Bollards can be manufactured with inner heavy duty steel inserts or with loose cap for concrete infill

**Visibility Bands:**

Retro reflective self-adhesive visibility bands can be applied. Wet painted and powder coated bands are also available

**Bespoke Options:**

Bollards can be manufactured to base plate fix, or be adapted to accept chains, rails or panels. Bollards can be made to be removable, or to fold down onto the ground or into a trough. Bollards can be adapted to make cycle stands, barriers etc. Door stoppers or door catches can be added.

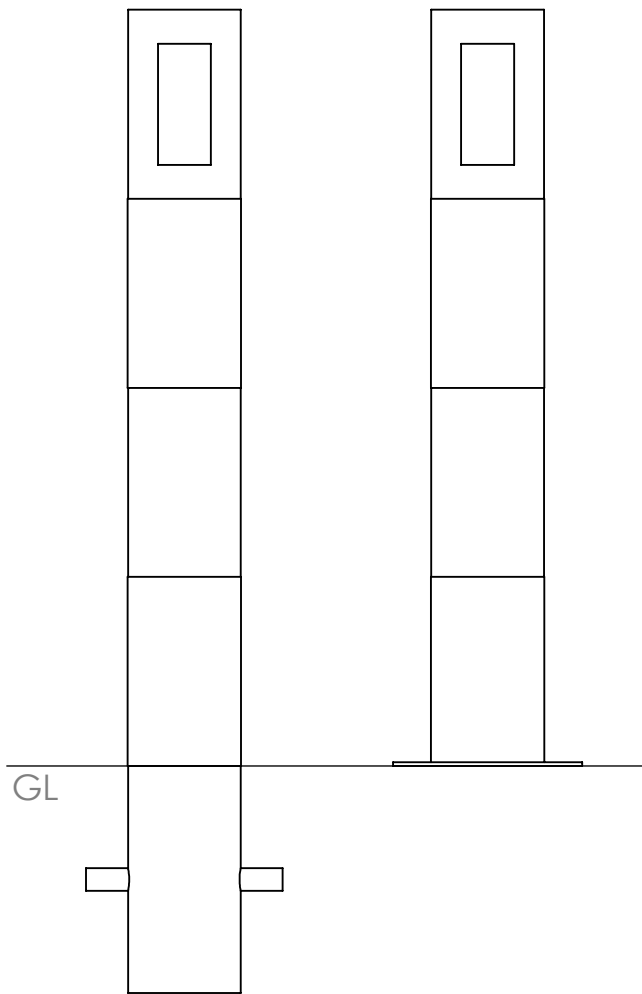

1:10

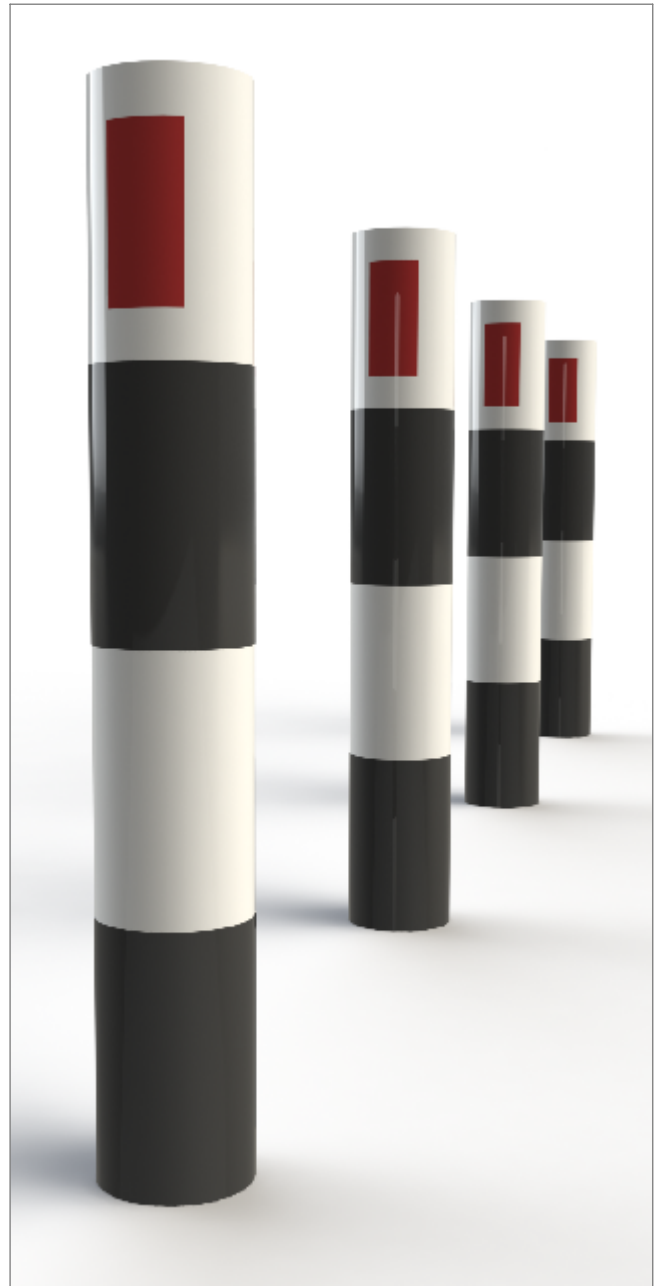

## Bollards | ASF 013 Steel Bollard

**Material:**

Manufactured in 275 carbon steel from recycled sources

**Diameter:**

Manufactured as standard in 114mm diameter. Also available in 76mm, 89mm, 101mm, 129mm, 168mm and 193mm diameters. Other sizes available if required

**Height:**

Bollards are manufactured either 1200mm long (900mm above ground) or 1500mm long (1000mm above ground) All other bollard sizes are available if required

**Standard Finish:**

As standard ASF Steel Bollards are finished hot dip galvanised

**Optional Finish:**

Bollards can be polyester powder coated, nylon coated or wet painted

**Ram Raid Options:**

Bollards can be manufactured with inner heavy duty steel inserts or with loose cap for concrete infill

**Visibility Bands:**

Retro reflective self-adhesive visibility bands can be applied. Wet painted and powder coated bands are also available

**Bespoke Options:**

Bollards can be manufactured to base plate fix, or be adapted to accept chains, rails or panels. Bollards can be made to be removable, or to fold down onto the ground or into a trough. Bollards can be adapted to make cycle stands, barriers etc. Door stoppers or door catches can be added.

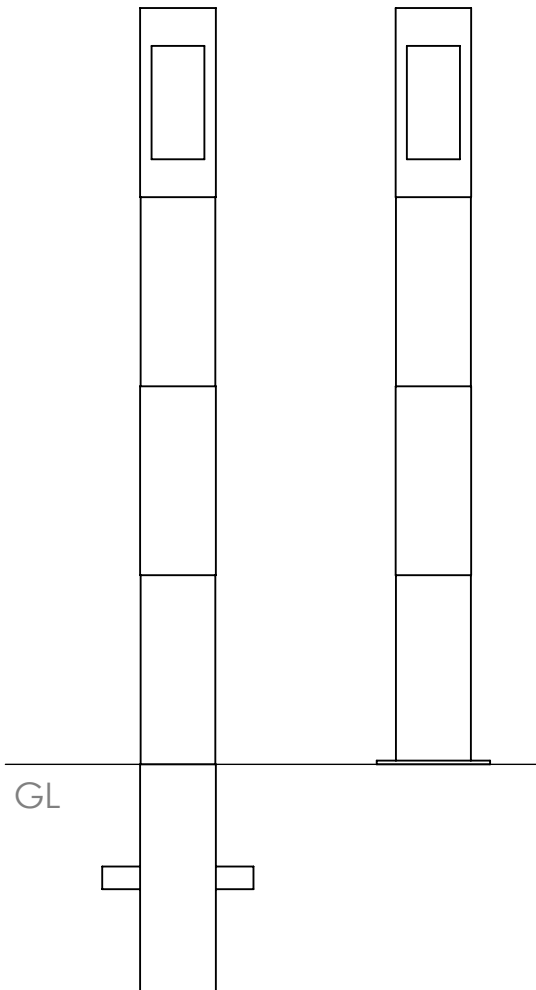

1:10

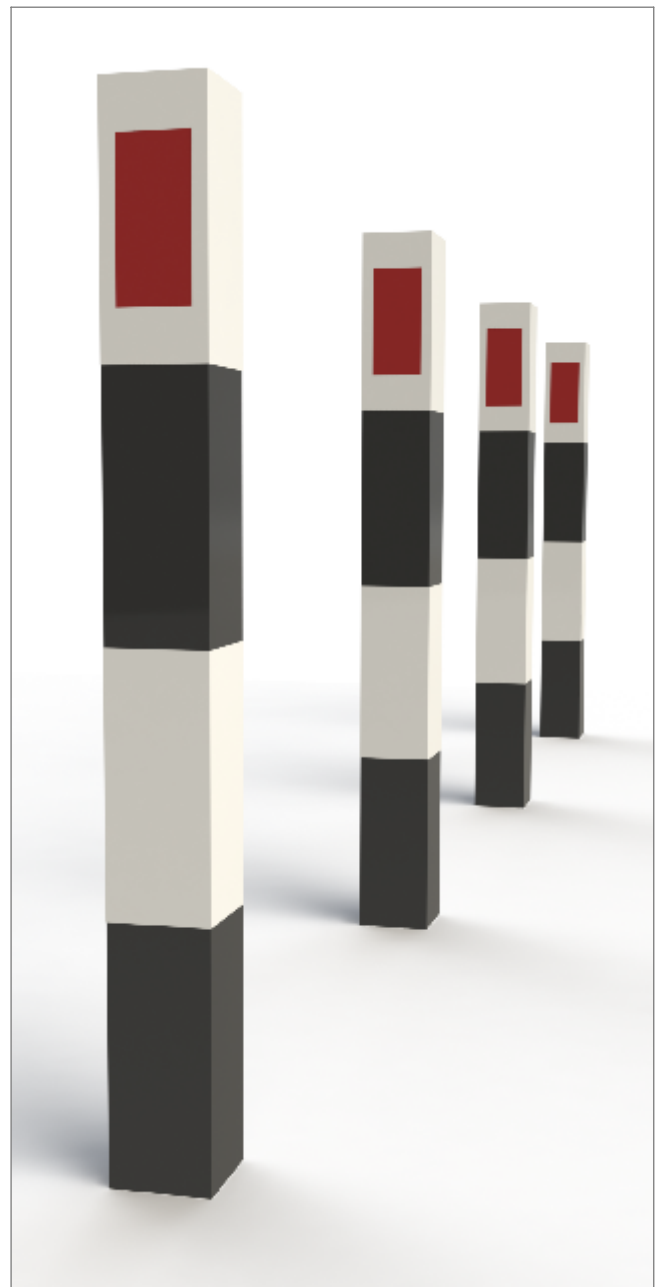

## Bollards | ASF 014 Square Steel Bollard

**Material:**  
**Dimensions**

Manufactured in 275 carbon steel from recycled sources

As standard ASF square steel bollards are manufactured 150mmSQ. Also available in 100mm and 200mmSQ. Other sizes available if required

**Height:**

Bollards are manufactured either 1200mm long (900mm above ground) or 1500mm long (1000mm above ground) All other bollard sizes are available if required

**Standard Finish:**

As standard ASF Steel Bollards are finished hot dip galvanised

**Optional Finish:**

Bollards can be polyester powder coated, nylon coated or wet painted

**Ram Raid Options:**

Bollards can be manufactured with inner heavy duty steel inserts or with loose cap for concrete infill

**Visibility Bands:**

Retro reflective self-adhesive visibility bands can be applied. Wet painted and powder coated bands are also available

**Bespoke Options:**

Bollards can be manufactured to base plate fix, or be adapted to accept chains, rails or panels. Bollards can be made to be removable, or to fold down onto the ground or into a trough. Bollards can be adapted to make cycle stands, barriers etc. Door stoppers or door catches can be added.

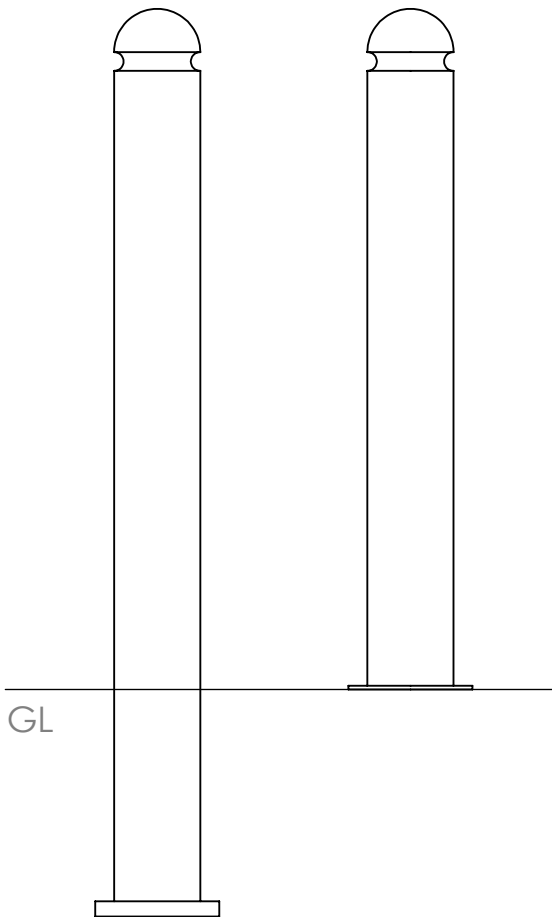

1:10



## Bollards | ASF 015 Steel Bollard

**Material:**

Manufactured in 275 carbon steel from recycled sources

**Diameter:**

Manufactured as standard in 114mm diameter. Also available in 76mm, 89mm, 101mm, 129mm, 168mm and 193mm diameters. Other sizes available if required

**Height:**

Bollards are manufactured either 1200mm long (900mm above ground) or 1500mm long (1000mm above ground) All other bollard sizes are available if required

**Standard Finish:**

As standard ASF Steel Bollards are finished hot dip galvanised

**Optional Finish:**

Bollards can be polyester powder coated, nylon coated or wet painted

**Ram Raid Options:**

Bollards can be manufactured with inner heavy duty steel inserts or with loose cap for concrete infill

**Visibility Bands:**

Retro reflective self-adhesive visibility bands can be applied. Wet painted and powder coated bands are also available

**Bespoke Options:**

Bollards can be manufactured to base plate fix, or be adapted to accept chains, rails or panels. Bollards can be made to be removable, or to fold down onto the ground or into a trough. Bollards can be adapted to make cycle stands, barriers etc. Door stoppers or door catches can be added.

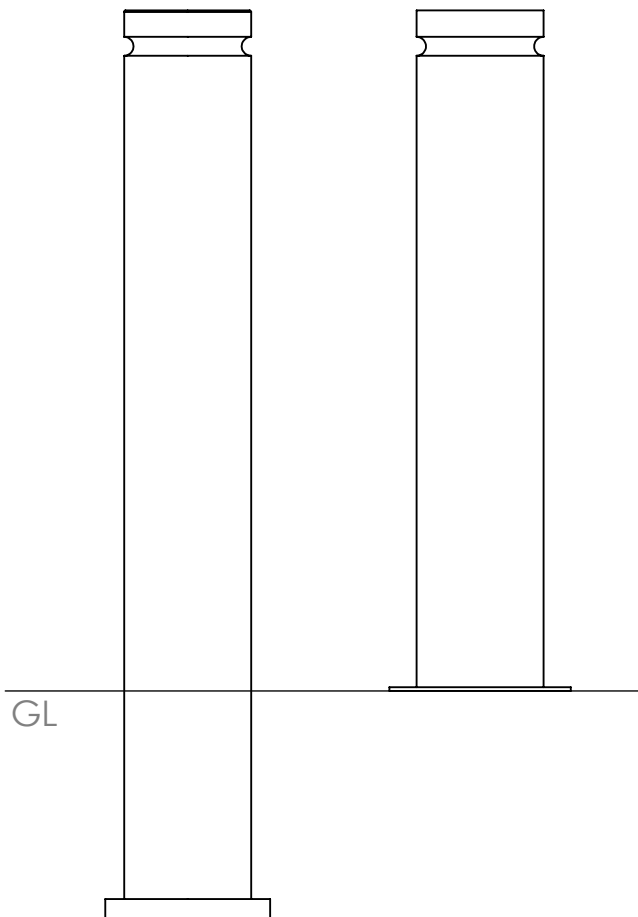

1:10

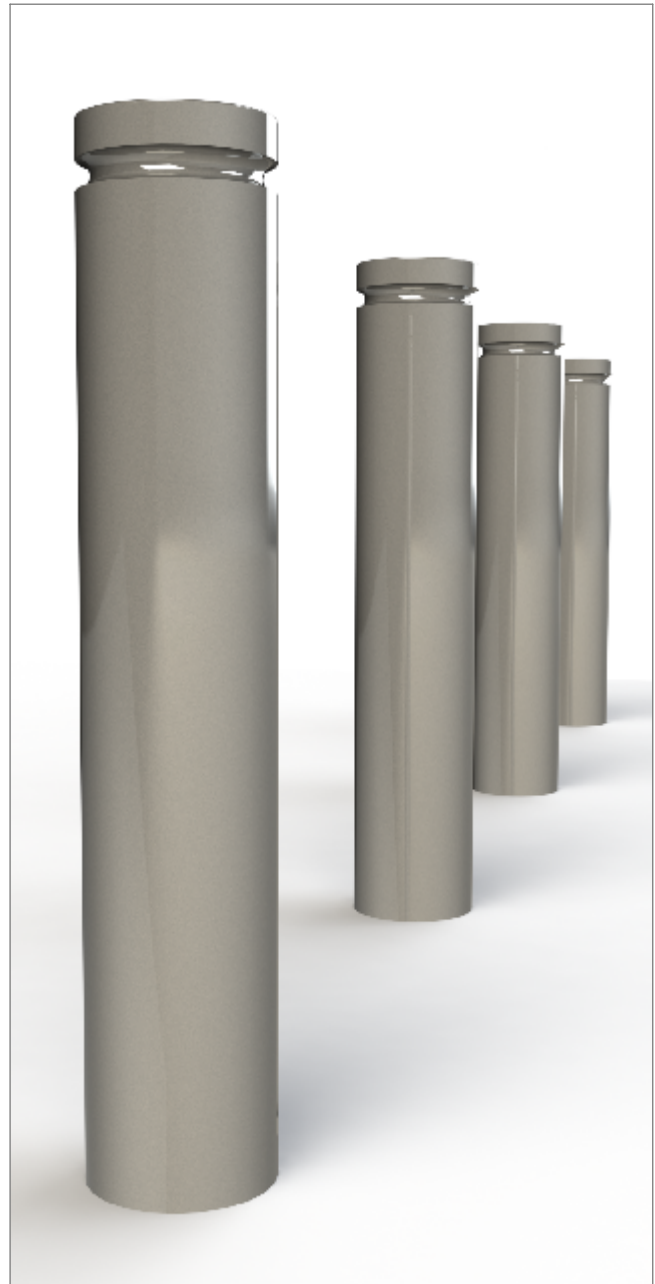

## Bollards | ASF 016 Steel Bollard

**Material:**

Manufactured in 275 carbon steel from recycled sources

**Diameter:**

Manufactured as standard in 114mm diameter. Also available in 76mm, 89mm, 101mm, 129mm, 168mm and 193mm diameters. Other sizes available if required

**Height:**

Bollards are manufactured either 1200mm long (900mm above ground) or 1500mm long (1000mm above ground) All other bollard sizes are available if required

**Standard Finish:**

As standard ASF Steel Bollards are finished hot dip galvanised

**Optional Finish:**

Bollards can be polyester powder coated, nylon coated or wet painted

**Ram Raid Options:**

Bollards can be manufactured with inner heavy duty steel inserts or with loose cap for concrete infill

**Visibility Bands:**

Retro reflective self-adhesive visibility bands can be applied. Wet painted and powder coated bands are also available

**Bespoke Options:**

Bollards can be manufactured to base plate fix, or be adapted to accept chains, rails or panels. Bollards can be made to be removable, or to fold down onto the ground or into a trough. Bollards can be adapted to make cycle stands, barriers etc. Door stoppers or door catches can be added.

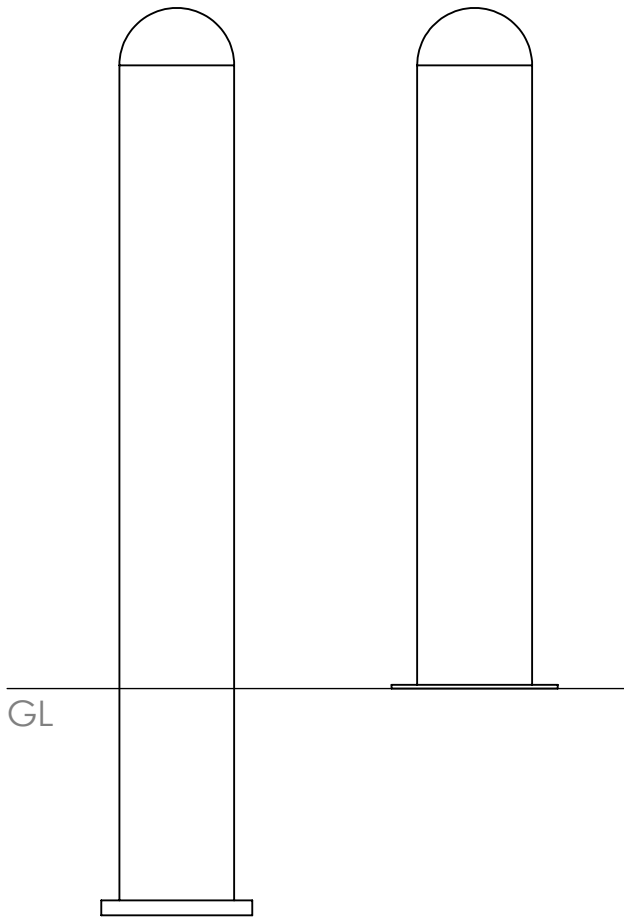

1:10

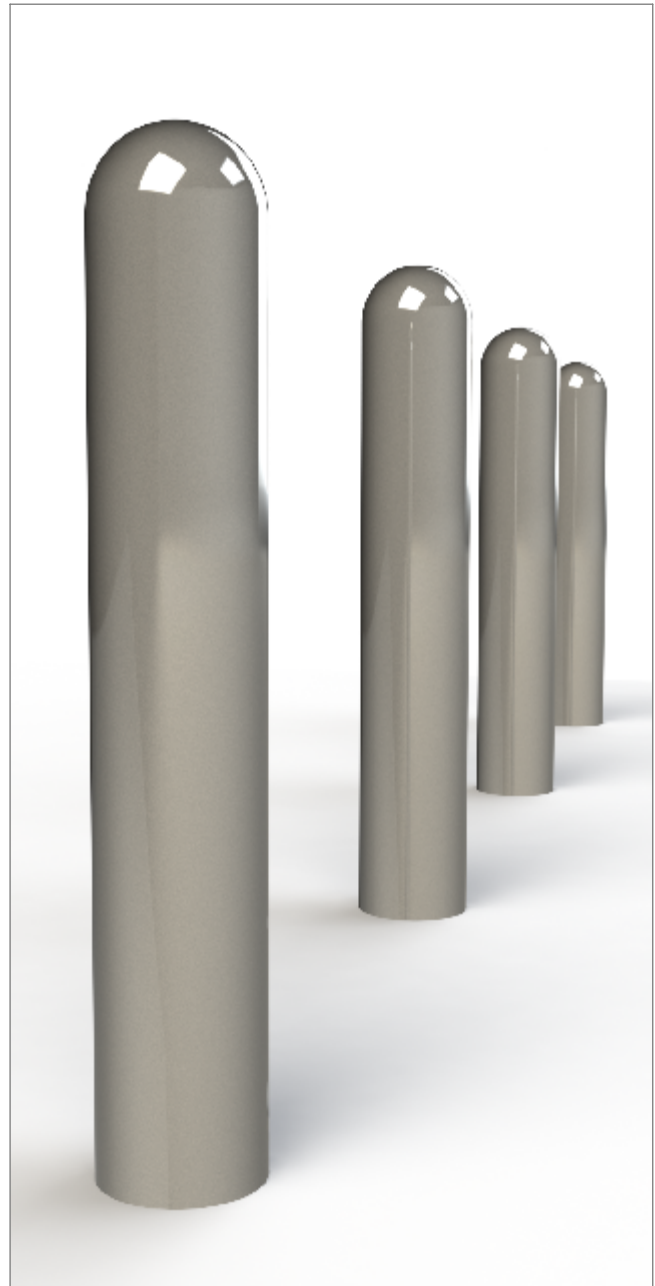

## Bollards | ASF 017 Steel Bollard

**Material:**

Manufactured in 275 carbon steel from recycled sources

**Diameter:**

Manufactured as standard in 114mm diameter. Also available in 76mm, 89mm, 101mm, 129mm, 168mm and 193mm diameters. Other sizes available if required

**Height:**

Bollards are manufactured either 1200mm long (900mm above ground) or 1500mm long (1000mm above ground) All other bollard sizes are available if required

**Standard Finish:**

As standard ASF Steel Bollards are finished hot dip galvanised

**Optional Finish:**

Bollards can be polyester powder coated, nylon coated or wet painted

**Ram Raid Options:**

Bollards can be manufactured with inner heavy duty steel inserts or with loose cap for concrete infill

**Visibility Bands:**

Retro reflective self-adhesive visibility bands can be applied. Wet painted and powder coated bands are also available

**Bespoke Options:**

Bollards can be manufactured to base plate fix, or be adapted to accept chains, rails or panels. Bollards can be made to be removable, or to fold down onto the ground or into a trough. Bollards can be adapted to make cycle stands, barriers etc. Door stoppers or door catches can be added.

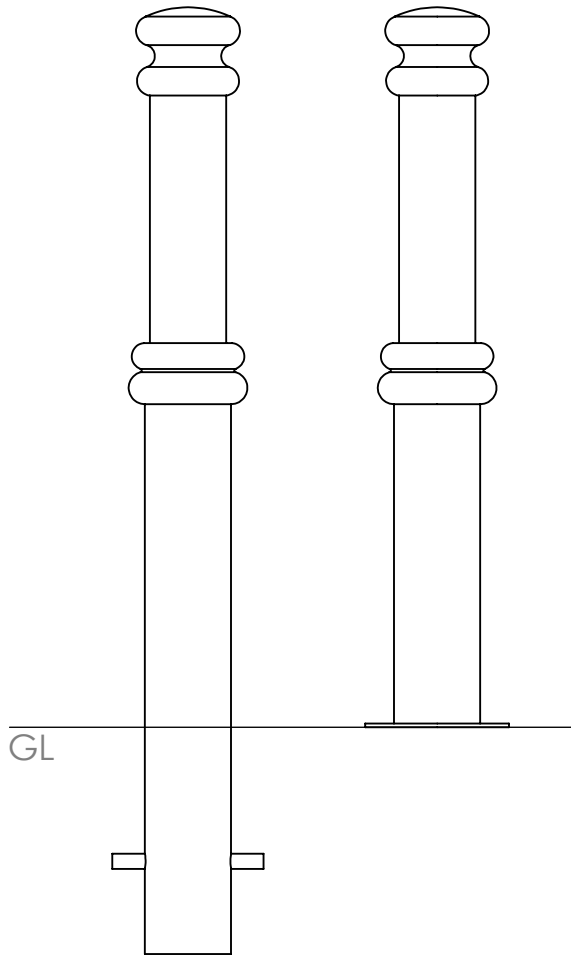

1:10



## Bollards | ASF 018 Steel Bollard

**Material:**

Manufactured in 275 carbon steel from recycled sources

**Diameter:**

Manufactured as standard in 114mm diameter. Also available in 76mm, 89mm, 101mm, 129mm, 168mm and 193mm diameters. Other sizes available if required

**Height:**

Bollards are manufactured either 1200mm long (900mm above ground) or 1500mm long (1000mm above ground) All other bollard sizes are available if required

**Standard Finish:**

As standard ASF Steel Bollards are finished hot dip galvanised

**Optional Finish:**

Bollards can be polyester powder coated, nylon coated or wet painted

**Ram Raid Options:**

Bollards can be manufactured with inner heavy duty steel inserts or with loose cap for concrete infill

**Visibility Bands:**

Retro reflective self-adhesive visibility bands can be applied. Wet painted and powder coated bands are also available

**Bespoke Options:**

Bollards can be manufactured to base plate fix, or be adapted to accept chains, rails or panels. Bollards can be made to be removable, or to fold down onto the ground or into a trough. Bollards can be adapted to make cycle stands, barriers etc. Door stoppers or door catches can be added.

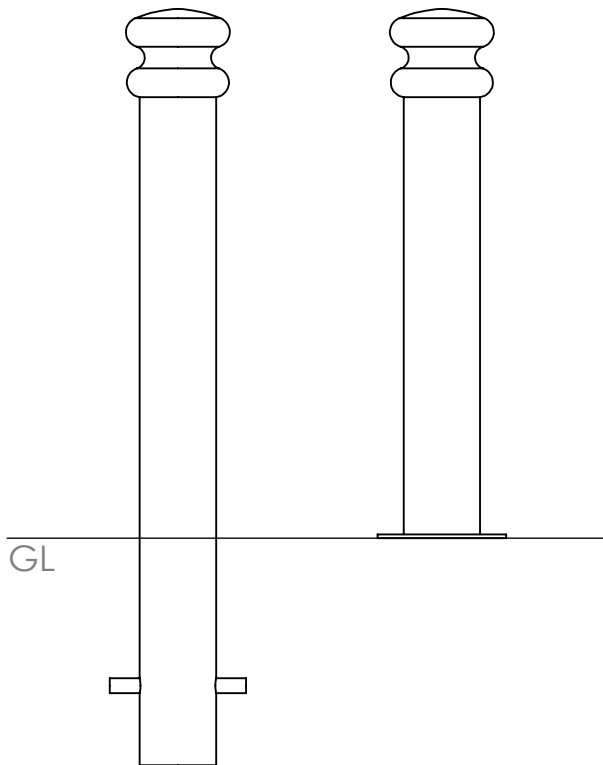

1:10



## Bollards | ASF 019 Steel Bollard

**Material:**

Manufactured in 275 carbon steel from recycled sources

**Diameter:**

Manufactured as standard in 114mm diameter. Also available in 76mm, 89mm, 101mm, 129mm, 168mm and 193mm diameters. Other sizes available if required

**Height:**

Bollards are manufactured either 1200mm long (900mm above ground) or 1500mm long (1000mm above ground) All other bollard sizes are available if required

**Standard Finish:**

As standard ASF Steel Bollards are finished hot dip galvanised

**Optional Finish:**

Bollards can be polyester powder coated, nylon coated or wet painted

**Ram Raid Options:**

Bollards can be manufactured with inner heavy duty steel inserts or with loose cap for concrete infill

**Visibility Bands:**

Retro reflective self-adhesive visibility bands can be applied. Wet painted and powder coated bands are also available

**Bespoke Options:**

Bollards can be manufactured to base plate fix, or be adapted to accept chains, rails or panels. Bollards can be made to be removable, or to fold down onto the ground or into a trough. Bollards can be adapted to make cycle stands, barriers etc. Door stoppers or door catches can be added.



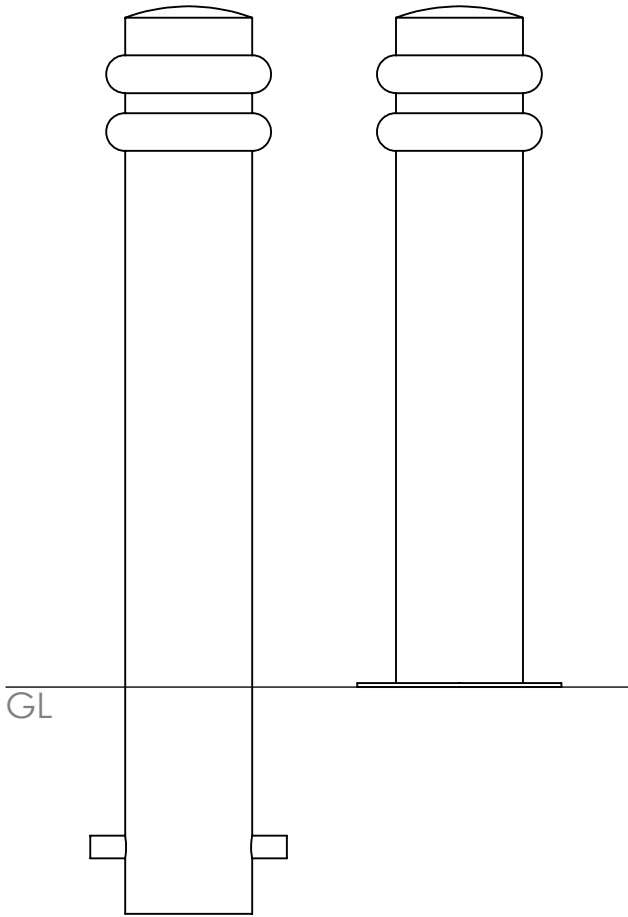

1:10

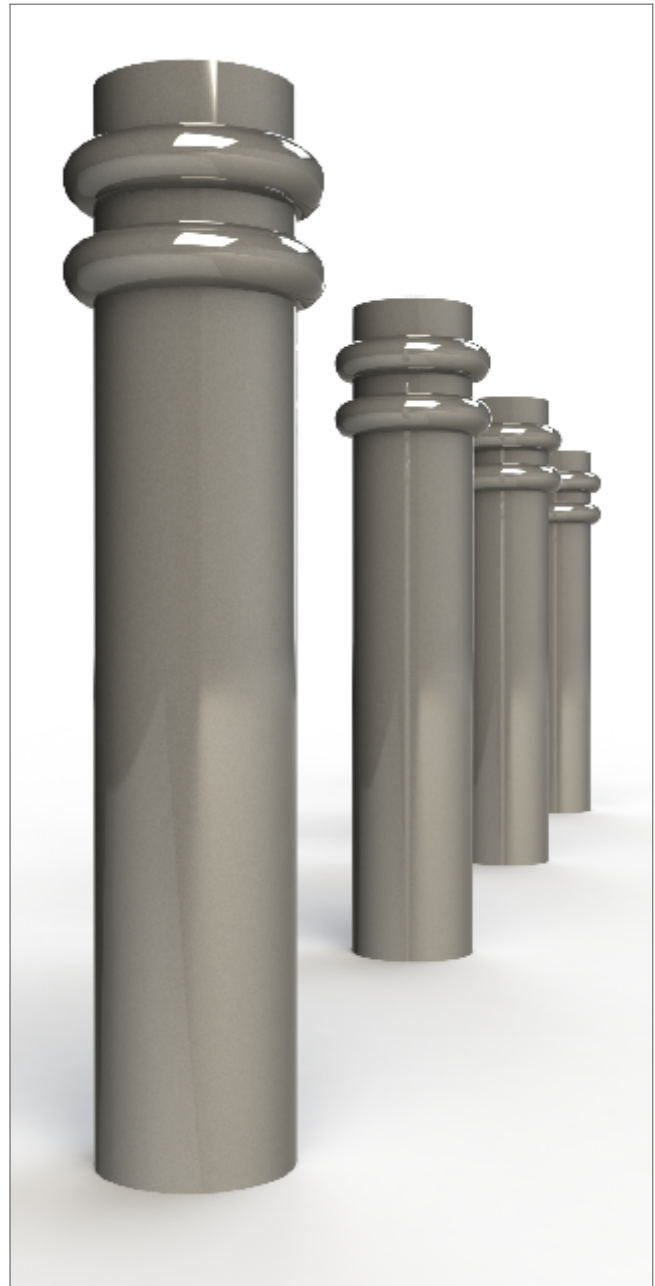

## Bollards | ASF 020 Steel Bollard

**Material:**

Manufactured in 275 carbon steel from recycled sources

**Diameter:**

Manufactured as standard in 114mm diameter. Also available in 76mm, 89mm, 101mm, 129mm, 168mm and 193mm diameters. Other sizes available if required

**Height:**

Bollards are manufactured either 1200mm long (900mm above ground) or 1500mm long (1000mm above ground) All other bollard sizes are available if required

**Standard Finish:**

As standard ASF Steel Bollards are finished hot dip galvanised

**Optional Finish:**

Bollards can be polyester powder coated, nylon coated or wet painted

**Ram Raid Options:**

Bollards can be manufactured with inner heavy duty steel inserts or with loose cap for concrete infill

**Visibility Bands:**

Retro reflective self-adhesive visibility bands can be applied. Wet painted and powder coated bands are also available

**Bespoke Options:**

Bollards can be manufactured to base plate fix, or be adapted to accept chains, rails or panels. Bollards can be made to be removable, or to fold down onto the ground or into a trough. Bollards can be adapted to make cycle stands, barriers etc. Door stoppers or door catches can be added.

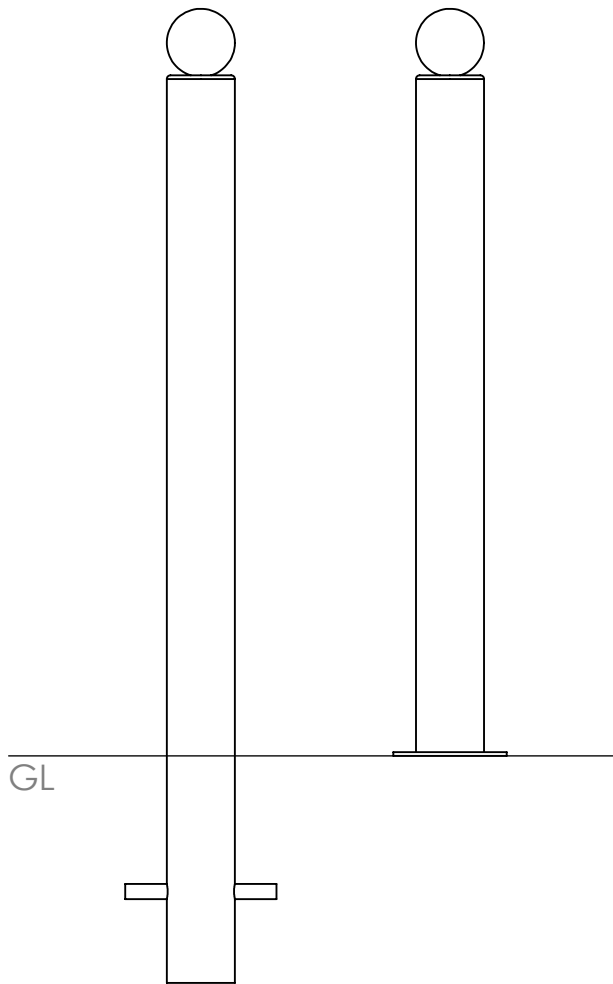

1:10

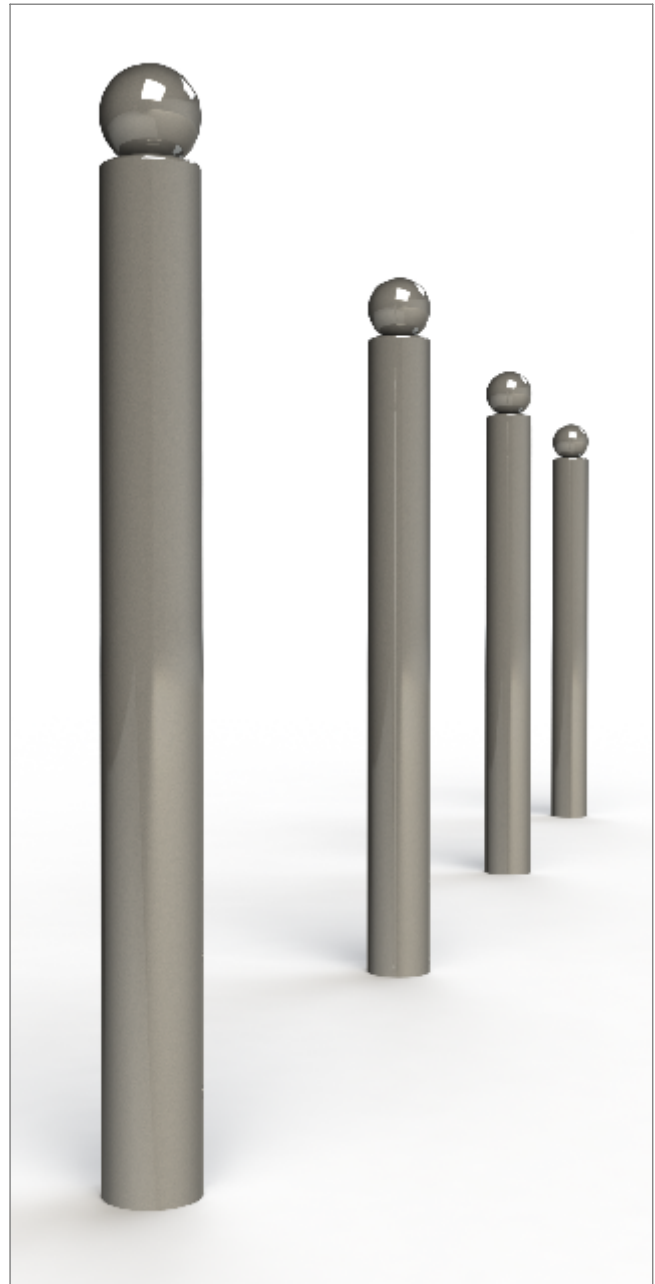

## Bollards | ASF 021 Steel Bollard

**Material:**

Manufactured in 275 carbon steel from recycled sources

**Diameter:**

Manufactured as standard in 114mm diameter. Also available in 76mm, 89mm, 101mm, 129mm, 168mm and 193mm diameters. Other sizes available if required

**Height:**

Bollards are manufactured either 1200mm long (900mm above ground) or 1500mm long (1000mm above ground) All other bollard sizes are available if required

**Standard Finish:**

As standard ASF Steel Bollards are finished hot dip galvanised

**Optional Finish:**

Bollards can be polyester powder coated, nylon coated or wet painted

**Ram Raid Options:**

Bollards can be manufactured with inner heavy duty steel inserts or with loose cap for concrete infill

**Visibility Bands:**

Retro reflective self-adhesive visibility bands can be applied. Wet painted and powder coated bands are also available

**Bespoke Options:**

Bollards can be manufactured to base plate fix, or be adapted to accept chains, rails or panels. Bollards can be made to be removable, or to fold down onto the ground or into a trough. Bollards can be adapted to make cycle stands, barriers etc. Door stoppers or door catches can be added.

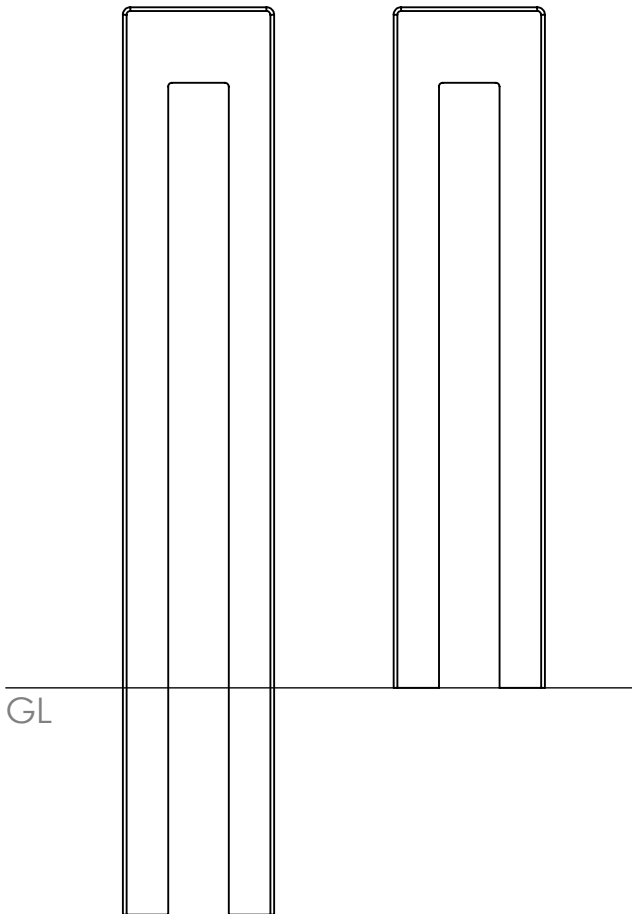

1:10

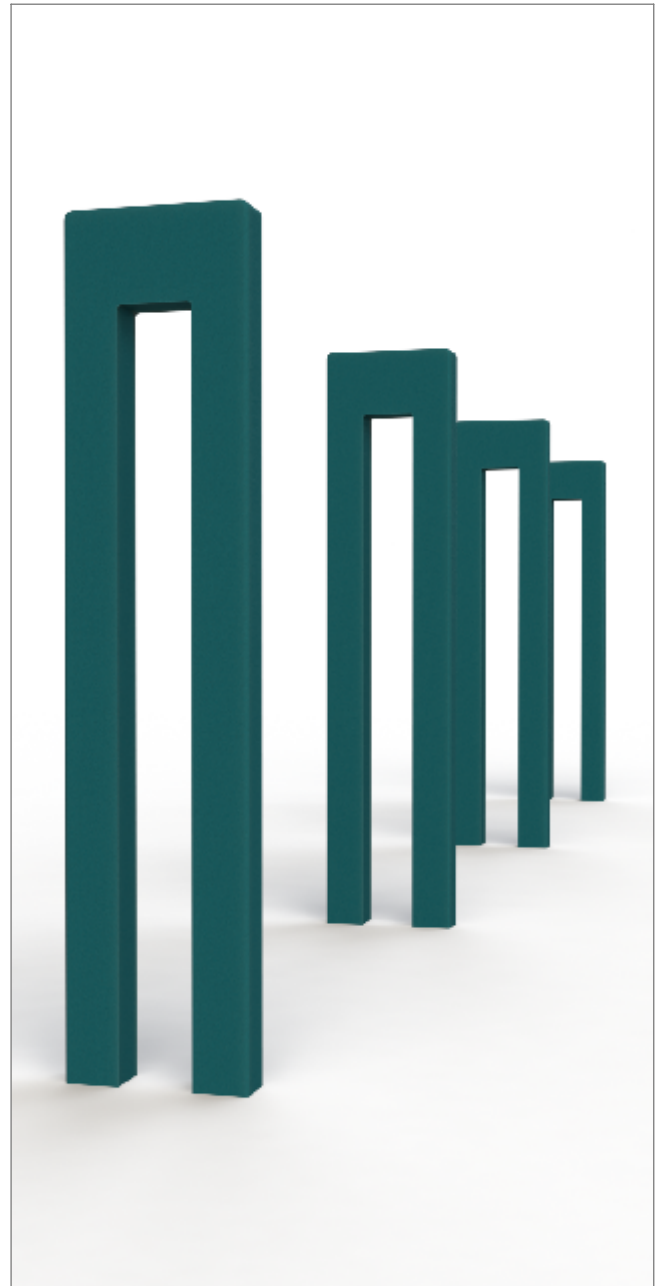

## Bollards | ASF 022 Rectangular Steel Bollard

**Material:**  
**Dimensions**  
**Height:**

**Standard Finish:**  
**Optional Finish:**  
**Visibility Bands:**

**Bespoke Options:**

Manufactured in 275 carbon steel from recycled sources

Manufactured in 50mm x 30mm rectangular section steel. Other sizes available on request

Bollards are manufactured either 1200mm long (900mm above ground) or 1500mm long (1000mm above ground) All other bollard sizes are available if required

As standard ASF Steel Bollards are finished hot dip galvanised

Bollards can be polyester powder coated, nylon coated or wet painted

Retro reflective self-adhesive visibility bands can be applied. Wet painted and powder coated bands are also available

Bollards can be manufactured to base plate fix, or be adapted to accept chains, rails or panels. Bollards can be made to be removable, or to fold down onto the ground or into a trough. Bollards can be adapted to make cycle stands, barriers etc. Door stoppers or door catches can be added.

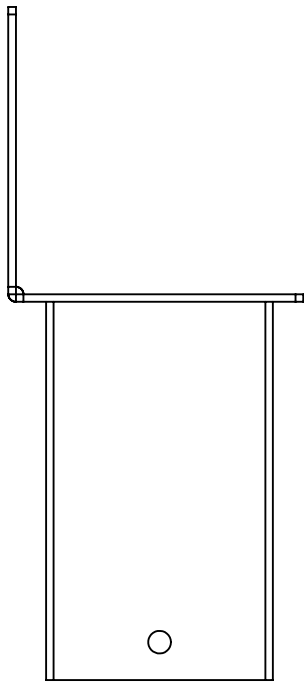
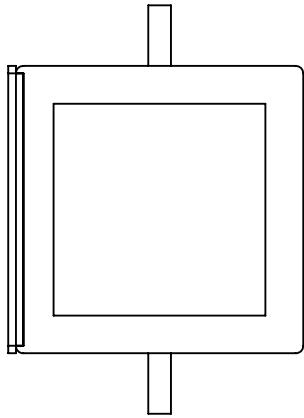

1:5

## Bollards | ASF 652 Bollard Ground Socket

**Material:**

Ground Sockets are manufactured to match the bollard material. Galvanised mild steel is used for cast iron, cast aluminium and steel bollards whilst stainless steel is used for stainless steel bollards.

**Finish:**

Ground sockets are finished to match bollards. All mild steel sockets are galvanised and stainless steel sockets are polished to match the bollards. Sockets can be painted if required.

**Options:**

Sockets can be manufactured to suit most bollard styles and dimensions are dictated by the bollard root dimensions. Socket lids can have anti slip surfaces if required.

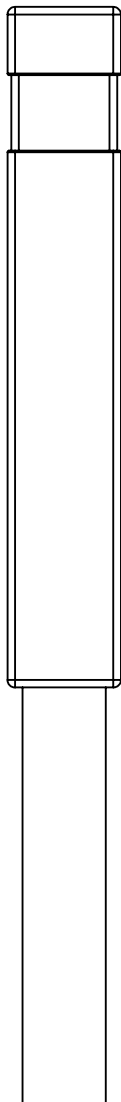
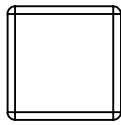

1:10

## Bollards | ASF Cubist Granite Bollard

**Dimensions:**

1450mm overall height. Available as standard 200mm, 250mm and 300mm Other sizes available

**Material:**

Available in grey granite, white granite & black crystal granite

**Finishes:**

Flame finished as standard. Also available bush hammered and polished

**Adaptions:**

ASF granite bollards can be retro-fitted with galvanised steel, stainless steel or timber ancillary features  
 ASF granite bollards can be supplied machined to accept retro fitted lighting fixtures

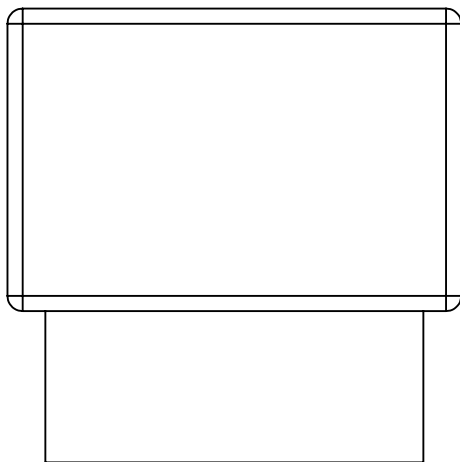
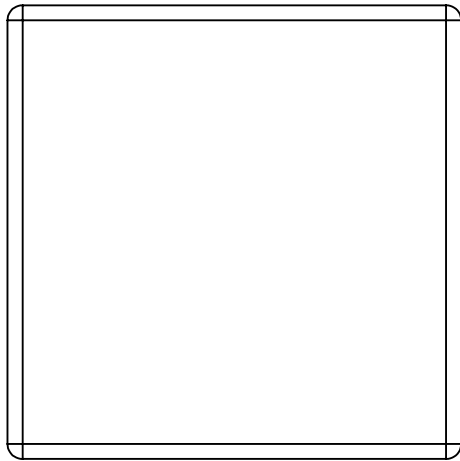

1:10

## Bollards | ASF Cubist Granite Bollard Seat

**Dimensions:**

**Material:**

**Finishes:**

**Adaptations:**

500mm overall height. Available as standard 600mm, 800mm and 1000mm Other sizes are available

Available in grey granite, white granite & black crystal granite

Flame finished as standard. Also available bush hammered and polished

ASF granite bollards can be retro-fitted with galvanised steel, stainless steel or timber ancillary features  
 ASF granite bollards can be supplied machined to accept retro fitted lighting fixtures

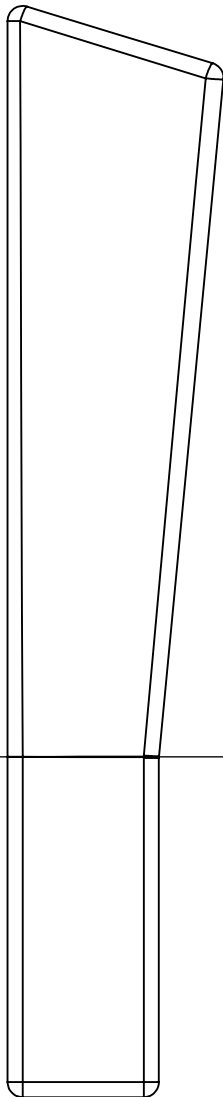
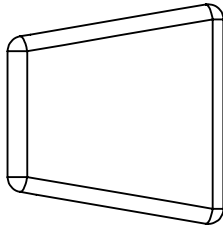

## Bollards | ASF Modernist 300 Granite Bollard

**Dimensions:**

**Material:**

**Finishes:**

**Adaptaions**

1450mm overall height. 300mm front to back at top of bollard. Other dimensions are available

Available in grey granite, white granite & black crystal granite

Flame finished as standard. Also available bush hammered and polished

ASF granite bollards can be retro-fitted with galvanised steel, stainless steel or timber ancillary features  
 ASF granite bollards can be supplied machined to accept retro fitted lighting fixtures

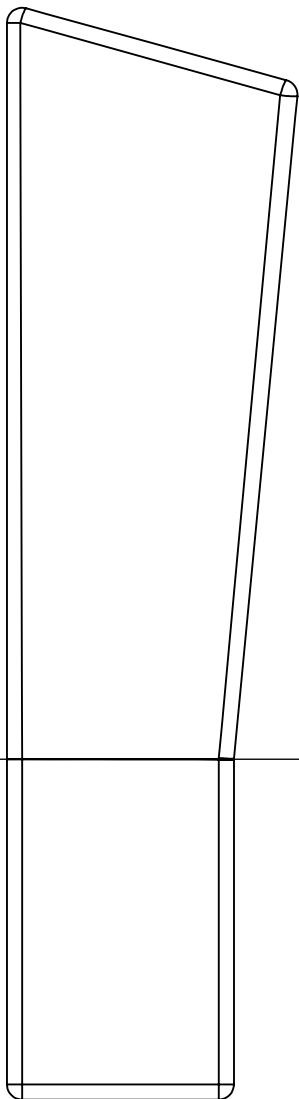
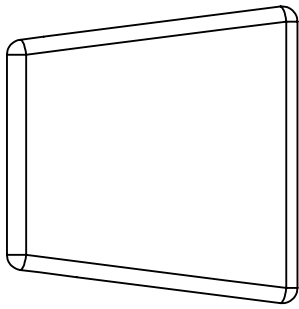

## Bollards | ASF Modernist 400 Granite Bollard

**Dimensions:**

1450mm overall height. 400mm front to back at top of bollard. Other dimensions are available

**Material:**

Available in grey granite, white granite & black crystal granite

**Finishes:**

Flame finished as standard. Also available bush hammered and polished

**Adaptations:**

ASF granite bollards can be retro-fitted with galvanised steel, stainless steel or timber ancillary features  
 ASF granite bollards can be supplied machined to accept retro fitted lighting fixtures



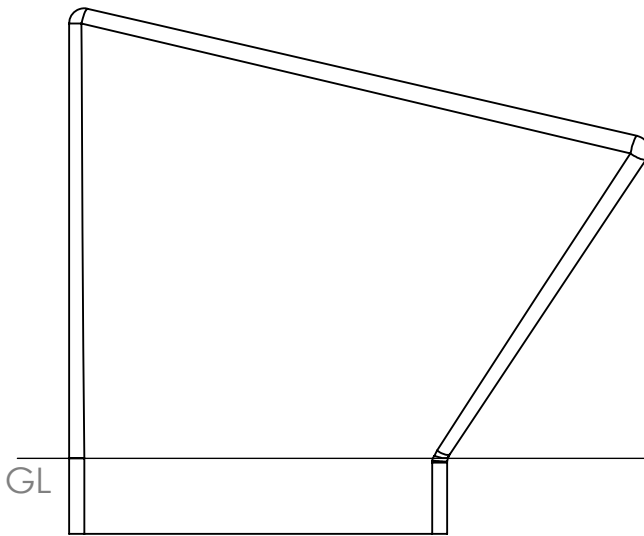
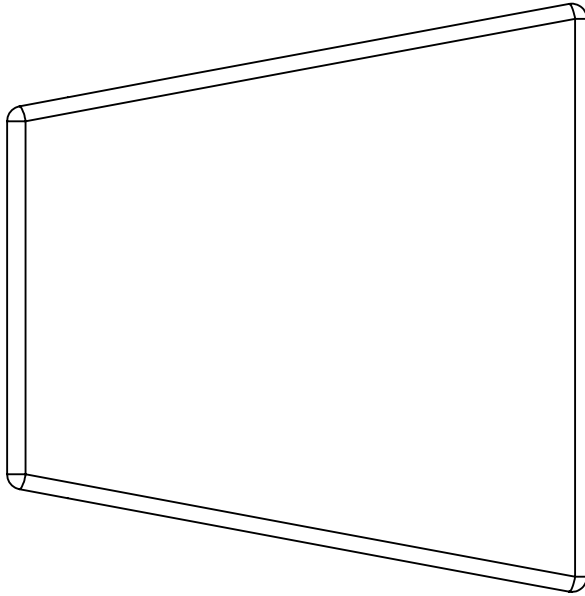

1:10

## Bollards | ASF Modernist 600 Granite Bollard Seat

**Dimensions:**

600mm overall height. 800mm front to back at top of bollard. Other dimensions are available

**Material:**

Available in grey granite, white granite & black crystal granite

**Finishes:**

Flame finished as standard. Also available bush hammered and polished

**Adaptions:**

ASF granite bollards can be retro-fitted with galvanised steel, stainless steel or timber ancillary features  
 ASF granite bollards can be supplied machined to accept retro fitted lighting fixtures

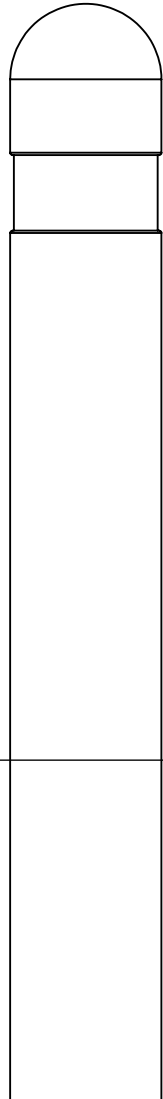
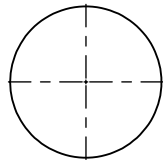

GL

1:10



## Bollards | ASF Organic Granite Bollard

**Dimensions:**

1450mm overall height. Available as standard in 200mm & 300mm diameter. Other dimensions are available

**Material:**

Available in grey granite, white granite & black crystal granite

**Finishes:**

Flame finished as standard. Also available bush hammered and polished

**Adaptions:**

ASF granite bollards can be retro-fitted with galvanised steel, stainless steel or timber ancillary features  
 ASF granite bollards can be supplied machined to accept retro fitted lighting fixtures

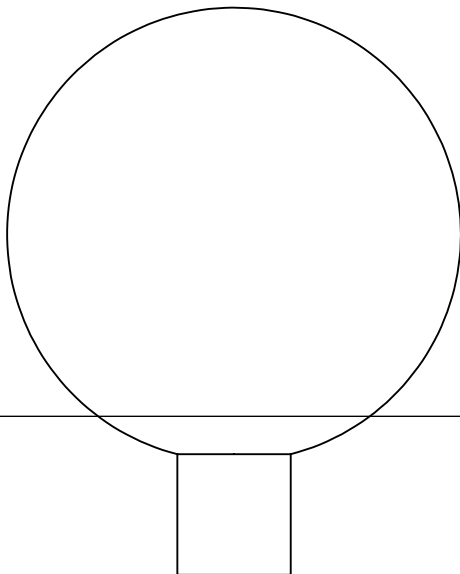
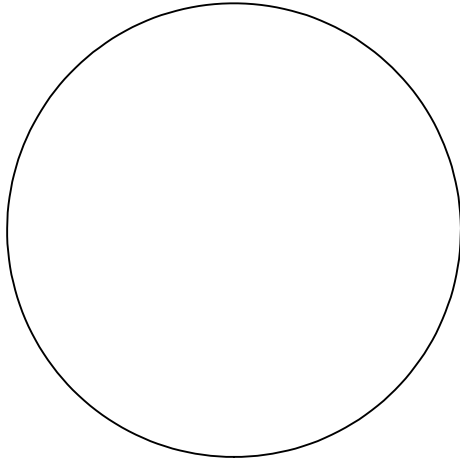

1:10

## Bollards | ASF Organic Spherical Granite Bollard

**Dimensions:**

**Material:**

**Finishes:**

**Adaptions:**

Available as standard in 400mm & 600mm diameter. Other dimensions are available

Available in grey granite, white granite & black crystal granite

Flame finished as standard. Also available bush hammered and polished

ASF granite bollards can be retro-fitted with galvanised steel, stainless steel or timber ancillary features  
 ASF granite bollards can be supplied machined to accept retro fitted lighting fixtures

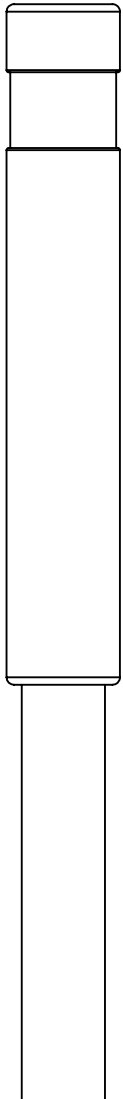
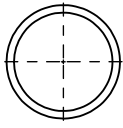

1:10

## Bollards | ASF Classic Granite Bollard

**Dimensions:**

1450mm overall height. Available as standard in 200mm, 250mm & 300mm diameter. Other dimensions are available

**Material:**

Available in grey granite, white granite & black crystal granite

**Finishes:**

Flame finished as standard. Also available bush hammered and polished

**Adaptions:**

ASF granite bollards can be retro-fitted with galvanised steel, stainless steel or timber ancillary features  
 ASF granite bollards can be supplied machined to accept retro fitted lighting fixtures

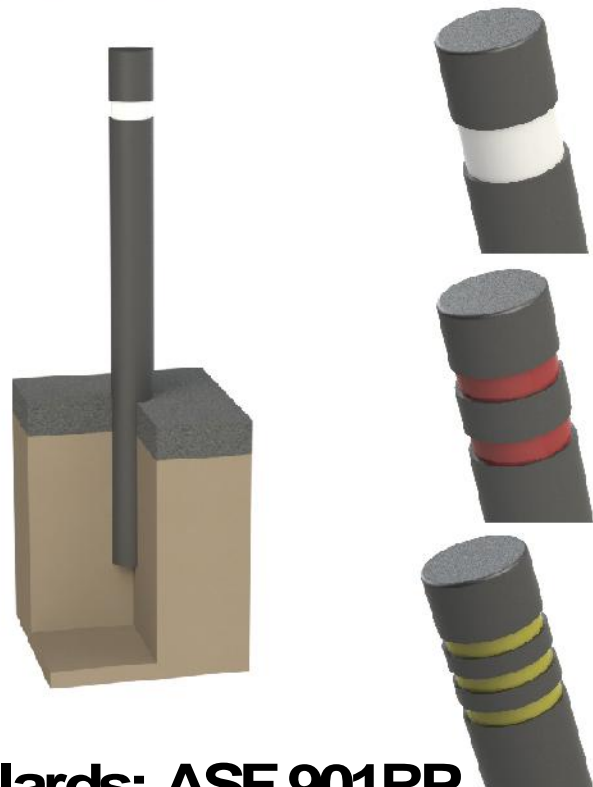
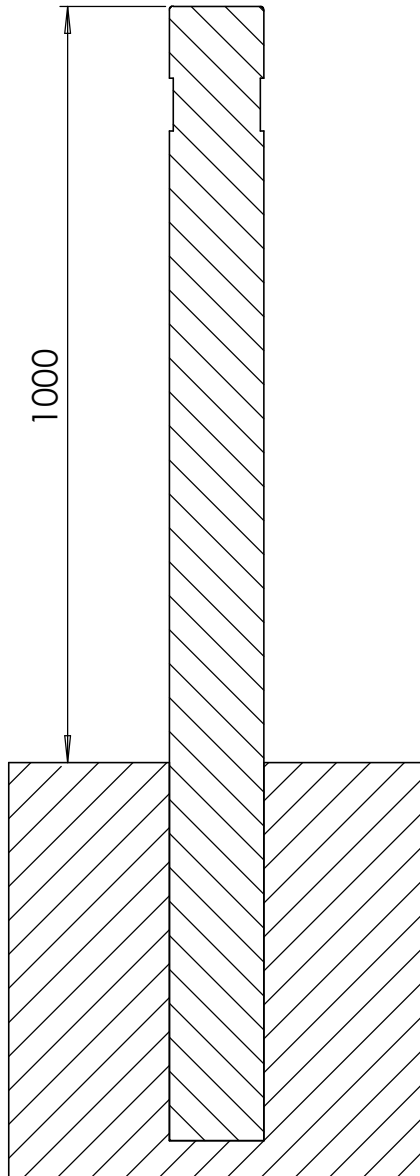

## ASF Recycled Plastic Bollards: ASF 901RP

**Material:**

Environmentally Impeccable 100% recycled plastic

**Dimensions:**

Bollards are available in 100mm, 120mm and 150mm diameter. Bollards are available in a variety of lengths

**Colour:**

ASF Enviro black. Other colours are available on request

**Visibility Bands:**

Visibility bands can be added in a machined recess

**Ram Raid:**

Whilst recycled plastic bollards are not designed as ram raid protection bollards, ASF can core them and add a steel core which strengthens them greatly. The steel used is from recycled sources

**Adaptations:**

Bollards can be adapted to form part of a post and rail system or have eyes added for chain links

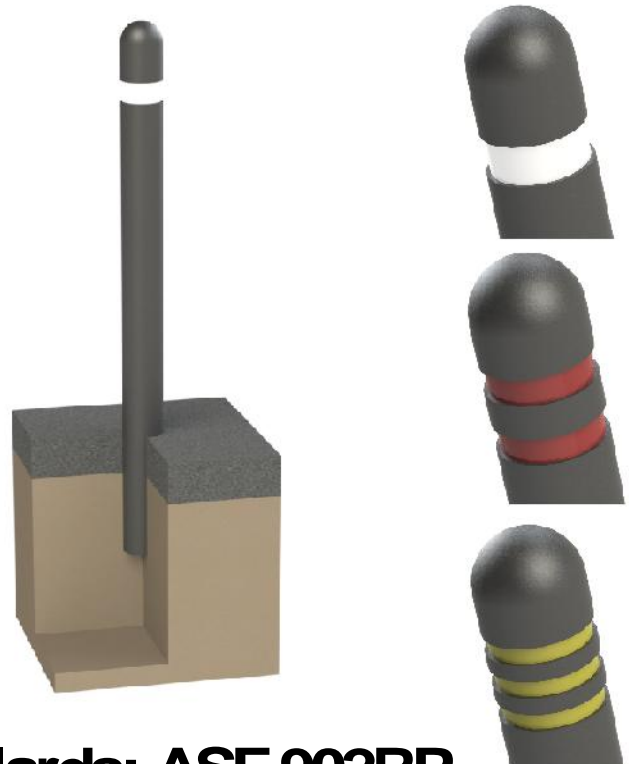
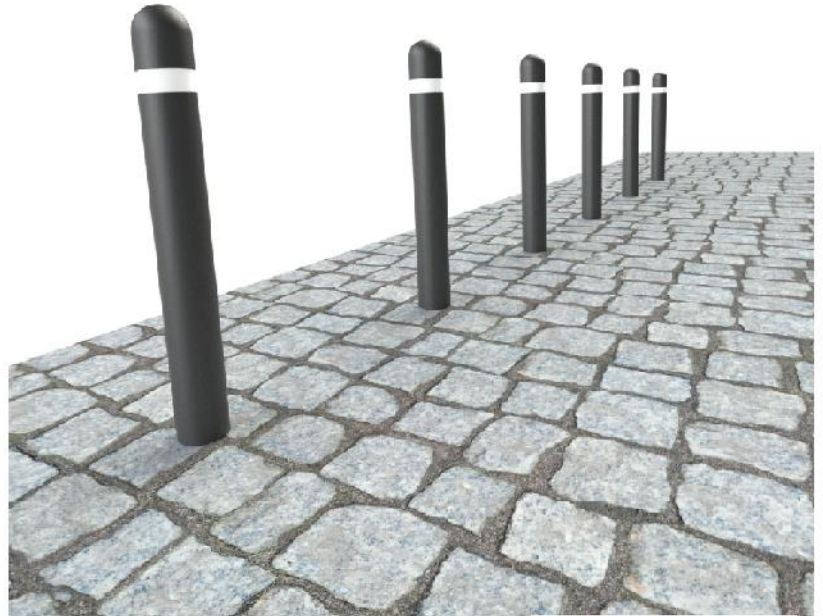
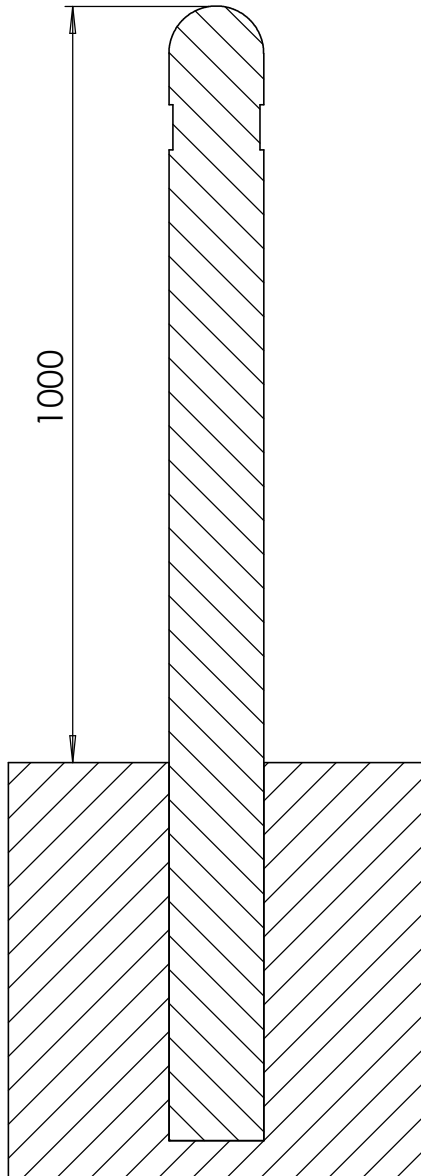

## ASF Recycled Plastic Bollards: ASF 902RP

**Material:**

Environmentally Impeccable 100% recycled plastic

**Dimensions:**

Bollards are available in 100mm, 120mm and 150mm diameter. Bollards are available in a variety of lengths

**Colour:**

ASF Enviro black. Other colours are available on request

**Visibility Bands:**

Visibility bands can be added in a machined recess

**Ram Raid:**

Whilst recycled plastic bollards are not designed as ram raid protection bollards, ASF can core them and add a steel core which strengthens them greatly. The steel used is from recycled sources

**Adaptations:**

Bollards can be adapted to form part of a post and rail system or have eyes added for chain links

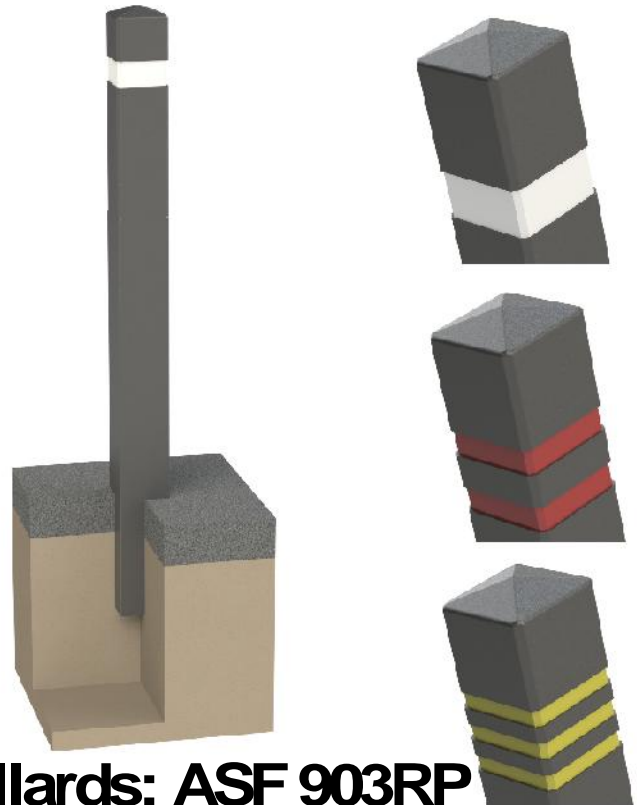
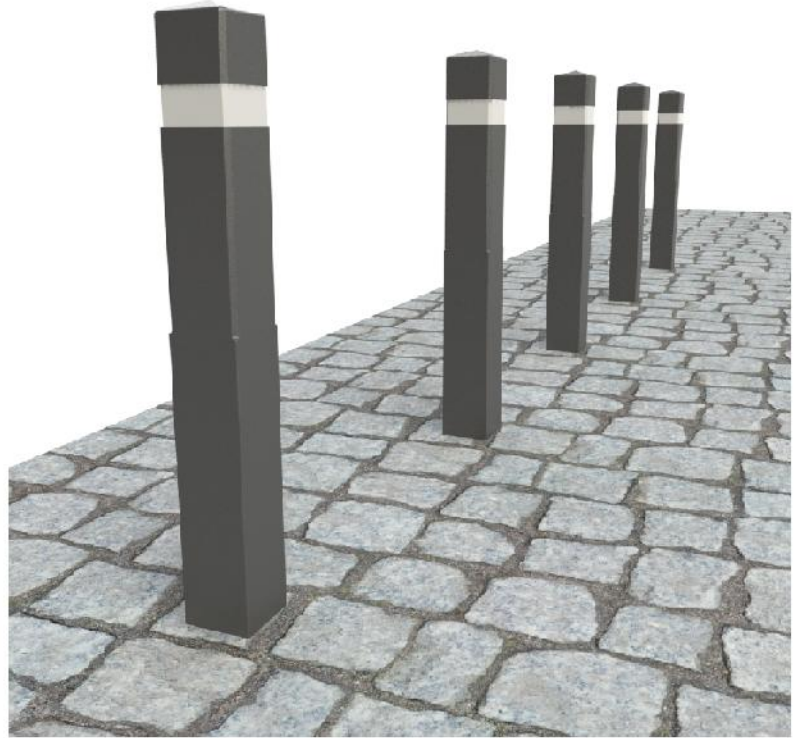
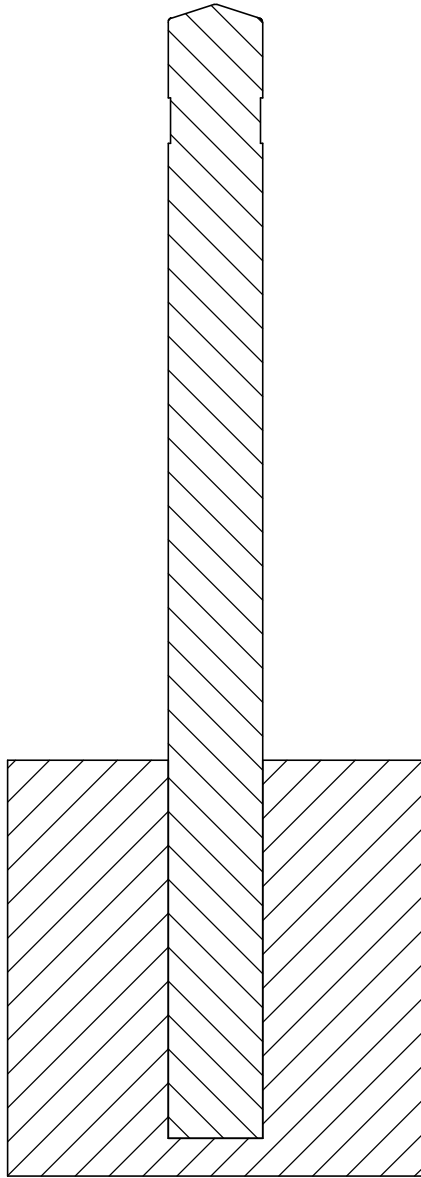

## ASF Recycled Plastic Bollards: ASF 903RP

**Material:**  
**Dimensions:**  
**Colour:**  
**Visibility Bands:**  
**Ram Raid:**  
**Adaptations:**

Environmentally Impeccable 100% recycled plastic  
 Bollards are 140mm square as standard and 1440mm long. Other sizes are available on request.  
 ASF Enviro black. Other colours are available on request  
 Visibility bands can be added in a machined recess  
 Whilst recycled plastic bollards are not designed as ram raid protection bollards, ASF can core them and add a steel core which strengthens them greatly. The steel used is from recycled sources  
 Bollards can be adapted to form part of a post and rail system or have eyes added for chain

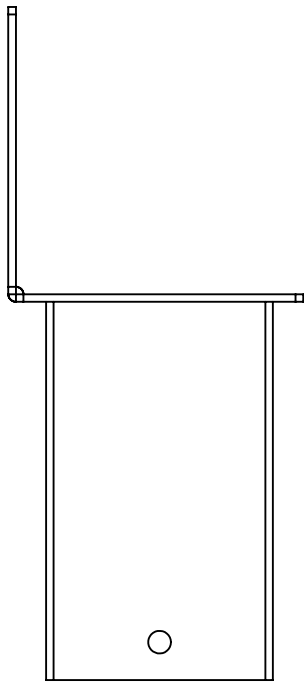
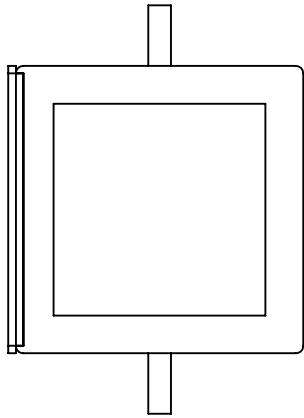

1:5

## Bollards | ASF 652 Bollard Ground Socket

**Material:**

Ground Sockets are manufactured to match the bollard material. Galvanised mild steel is used for cast iron, cast aluminium and steel bollards whilst stainless steel is used for stainless steel bollards.

**Finish:**

Ground sockets are finished to match bollards. All mild steel sockets are galvanised and stainless steel sockets are polished to match the bollards. Sockets can be painted if required.

**Options:**

Sockets can be manufactured to suit most bollard styles and dimensions are dictated by the bollard root dimensions. Socket lids can have anti slip surfaces if required.